



# City of Santa Fe, New Mexico

200 Lincoln Avenue, P.O. Box 909, Santa Fe, N.M. 87504-0909  
[www.santafenm.gov](http://www.santafenm.gov)

*Alan Webber, Mayor*

Councilors:

Signe I. Lindell, Mayor Pro Tem, District 1  
Alma G. Castro, District 1  
Michael J. Garcia, District 2  
Carol Romero-Wirth, District 2  
Lee Garcia, District 3  
Pilar F.H. Faulkner, District 3  
Jamie Cassutt, District 4  
Amanda Chavez, District 4

**DATE:** December 26, 2024  
**TO:** Finance Committee, Public Works and Utilities, and Governing Body  
**FROM:** James Harris, Airport Manager *Jeh*  
**VIA:** Kelly Bynon, Administrative Manager *Kelly Bynon*

## ITEM AND ISSUE:

Request For Approval to Accept the New Mexico Department of Transportation Aviation Division Grant # SAF-25-02 in the Amount of \$540,000 for the North Apron Reconstruction Project.

1. Request For Approval of a Budget Amendment Resolution (BAR) in the Total Amount of \$600,000 to Increase WIP Design and WIP Construction using New Mexico Department of Transportation Aviation Division Funding for the North Apron Reconstruction Project.

(James Harris, Airport Manager, [jcharris@santafenm.gov](mailto:jcharris@santafenm.gov); Kelly Bynon, Administrative Manager, [kabynon@santafenm.gov](mailto:kabynon@santafenm.gov))

## BACKGROUND AND SUMMARY:

New Mexico Department of Transportation Aviation Division Grant # SAF-25-02 in the Amount of \$540,000 for the North Apron Reconstruction Project. This state grant is a matching grant to FAA grant #3-35-0037-063-2024 that has already been accepted by Governing Body.

## ACTION:

Approval to Accept the New Mexico Department of Transportation Aviation Division Grant # SAF-25-02 in the Amount of \$540,000 for the North Apron Reconstruction Project.

1. Approval of a Budget Amendment Resolution (BAR) in the Total Amount of \$600,000 to Increase WIP Design and WIP Construction using New Mexico Department of Transportation Aviation Division Funding for the North Apron Reconstruction Project.

## COMMITTEE REVIEW:

Public Works & Utilities: 01/21/2025  
Finance Committee: 01/27/2025  
Governing Body: 01/29/2025



A-1330

Updated:07/2023

Aviation

**NEW MEXICO DEPARTMENT OF TRANSPORTATION**

**Aviation Grant Agreement Form**



Date

Nov 13, 2024

Project Location

SAF - SANTA FE MUNICIPAL AIRPORT

Sponsor

SANTA FE, CITY OF

Address

PO BOX 909

City

SANTA FE

NM

Zip Code

87504

Participation

FAA

Funding Breakdown

Contract No. AVA1643

Project No. SAF-25- 02

Vendor No. 0000054360

Expiration Date 12/1/2026

Purchase Order No: 0000410654

## AVIATION GRANT AGREEMENT

This Agreement is between the New Mexico Department of Transportation, acting through its Aviation Division (Department), and the Sponsor. This Agreement is effective pursuant to Section 7, below.

**Now Therefore**, pursuant to the New Mexico Aviation Act, NMSA 1978, Section 64-1-11 et seq., and the New Mexico Municipal Airport Law, NMSA 1978 Sections 3-39-1 et seq., the parties agree as follows:

**1. Purpose.**

The purpose of this Agreement is to provide funding, authorized in Section 64-1-13, NMSA 1978, to the Sponsor to assist in financing an aviation project.

a. Project Description:

NORTH APRON (Design & Re-Construct)

- b. Site of Development. The site of development is identified on the property map, attached as Exhibit A.
- c. Funding. Below is the funding for the Project. The State's contribution is the maximum amount that the Department will contribute. Attached as Exhibit B is the engineer's cost estimate.

State	Sponsor	Other	Total
\$ <span style="border: 1px solid black; padding: 5px;">540,000</span>	\$ <span style="border: 1px solid black; padding: 5px;">60,000</span>	\$ <span style="border: 1px solid black; padding: 5px;">5,400,000</span>	\$ <span style="border: 1px solid black; padding: 5px;">6,000,000</span>

**2. The Sponsor Shall:**

- a. Pay all costs, perform all labor, and supply all material, except as described in the Engineers Estimate attached as EXHIBIT B.
- b. Provide a representative from its organization who shall serve as the single point of contact for the Department.
- c. Establish and maintain a resolution by which the Sponsor agrees to establish an airport maintenance program and appoint an individual to be responsible for management of the program.
- d. Initiate engineering, survey, and all other design activities, inspect Project construction and, coordinate all meetings.
- e. Be responsible for all design and pre-construction activities.
- f. Initiate and cause to be prepared all necessary documents including plans, specifications, estimates (PS&E), and reports for this Project.
- g. Assure that all design and PS&E are performed under the direct supervision of a Registered New Mexico Professional Engineer.
- h. Design the Project in accordance with State and Federal guidelines and/or advisory circulars, hereby incorporated into this Agreement. Construction projects will be accomplished in accordance with the Federal Aviation Administration's Standards for Specifying Construction of Airports (Advisory Circular 150/5370-10, current edition).

- i. Notify the Department when the plans and specifications are sufficiently complete for review.
- j. Make no changes in design or scope of work without documented approval of the Department.
- k. Advertise for and contract for the construction of the Project in accordance with federal and state laws or local ordinances.
- l. Require the Engineer to prepare a final detailed estimate of the work, indicating the bid items, the quantity in each item, the unit bid price and cost of the items based on low acceptable bid prices. Progress estimates shall be submitted to the Department in acceptable form so that details of quantities allowed on various items of work shall be shown on each progress payment.
- m. The Sponsor shall submit to the Department one complete set of plans and specifications which incorporate all comments and recommendations received during pre-bid activities and which have been fully executed by all involved parties.
- n. The Sponsor shall take all steps, including litigation if necessary, to recover State funds spent in violation of state laws and rules. The Sponsor shall return any recovered state funds to the Department. It shall furnish to the Department, upon request, all documents and records pertaining to the determination of the amount of the state's share of any settlement, litigation, negotiation, or the efforts taken to recover such funds. All settlements or other final dispositions by the Sponsor, in court or otherwise, involving the recovery of such state funds shall be approved in advance by the Department.
- o. The Sponsor shall, upon reasonable notice, allow the Department the right to inspect the Project for the purposes of determining if it is being constructed in a good and workmanlike manner, and if the approved plans and specifications are being complied with satisfactorily. If an inspection discloses a failure to substantially meet such requirements and standards the Department may terminate payment or payments until a mutually satisfactory remedy is reached.

### **3. The Department Shall:**

- a. Assign a contact person for this project.
- b. Provide timely reviews of all submittals of scopes, plans, specifications, investigations or other documents.
- c. The Department shall not provide an extensive check of any plans submitted by the Sponsor. The Department's concurrence of the Project plans does not relieve the Sponsor or its Consultant of their responsibility for errors and omissions.

### **4. Both Parties Agree:**

- a. The allowable costs of this Project shall not include costs determined by the Department to be ineligible for consideration under the Aviation Act.
- b. The expenditure of any State money is subject to approval by the Department.
- c. Funds granted under the Local Governments Road Fund, NMSA 1978 Section 67-3-28.2, shall not be used to administer this Project or used to meet the local match.

### **5. Method of Payment - Reimbursement.**

The Department shall reimburse the Sponsor in accordance with the terms of this agreement. Claims for reimbursement shall be completed on form A-1159, Request for Reimbursement. Each request for reimbursement shall contain proof of payment for valid expenditures for services rendered by a third party or items of tangible property received by the Sponsor for the implementation of the Project. The Department reserves the right to withhold reimbursement on requests that are incorrect and/or incomplete. The Final reimbursement request must be received no later than thirty (30) days after completion of the project or the expiration of this Agreement.

The Sponsor shall not be reimbursed for any costs incurred prior to the full execution of the Agreement, after the expiration of the Agreement or in excess of the maximum dollar amount of the agreement unless the maximum dollar amount is duly amended prior to incurring the service or deliverable. Any unexpended portion of funds subject to this Agreement shall revert to the State Aviation Fund.

### **6. Accountability of Receipts and Disbursements.**

There shall be strict accountability for all receipts and disbursements. The Sponsor shall maintain all records and documents relative to the Project for a minimum of three (3) years after completion of said Project. The Sponsor shall furnish the Department or State Auditor, upon demand, all records which support the terms of this Agreement.

The Agreement becomes effective upon signatures of all parties. The Agreement's effective date is the date opposite of the NMDOT Cabinet Secretary or Designee's signature on the signature page. This agreement shall expire two (2) years from the effective date, unless terminated pursuant to Sections 8 and 17, below.

### **8. Termination for Cause.**

The Department has the option to terminate this Agreement if the Sponsor fails to comply with any provision of this Agreement. A written notice of termination shall be given at least thirty (30) days prior to the intended date of termination and shall identify all of the Sponsor's breaches on which the termination is based.

The Department may provide the Sponsor a reasonable opportunity to correct the breach. If within ten (10) days after receipt of a written notice of termination, the Sponsor has not corrected the breach or, in the case of a breach which cannot be corrected in ten (10) days, the Sponsor has not begun and proceeded in good faith to correct the breach, the Department may declare the Sponsor in default and terminate the Agreement. The Department shall retain any and all other remedies available to it under the law.

By such termination neither party may nullify obligations already incurred for performance or failure to perform for the work rendered prior to the date of termination. However, neither party shall have any obligation to perform services or make payment for services rendered after such date of termination.

### **9. Disposition of Property.**

- a. Upon termination of this Agreement, the Sponsor shall account for any remaining property, materials or equipment belonging to the Department and dispose of them as directed by the Department.
- b. Any equipment, materials or supplies procured under this Agreement shall be used solely for aviation purposes maintained according to the manufacturers guidelines and stored at the airport.

### **10. Representations and Certification.**

The Sponsor, by signing this Agreement, represents and certifies the following:

- a. Legal Authority - The Sponsor has the legal power and authority to: (1) do all things necessary in order to undertake and carry out the Project in conformity with the provisions stated in the New Mexico Aviation Act and Rules and Regulations pursuant thereto; (2) accept, receive and disburse grant funds from the State of New Mexico in aid of the Project; and (3) carry out all provisions stated in this Aviation Grant Agreement.
- b. Defaults - The Sponsor is not in default on any obligation to the State of New Mexico relative to the development, operation or maintenance of any airport or aviation project.
- c. Possible Disabilities - The Sponsor states, by execution of this Agreement, there are no facts or circumstance (including the existence of effective or proposed leases, use agreements, or other legal instruments affecting use of the airport or the existence of pending litigation or other legal proceedings) which in reasonable probability might make it impossible for the Sponsor to carry out and complete the Project.
- d. Land - The Sponsor holds the property interest in the areas of land which are to be developed or used as part of or in connection with the Project and is identified in a current Airport Property Map. The Sponsor further certifies that the aforementioned is based on a title examination by a qualified attorney or title company who has determined that the Sponsor holds the stated property interests.

### **11. Assurances.**

The Sponsor, by signing this Agreement, covenants and agrees to the following Assurances:

- a. That it will operate the airport for the use and benefit of the public on fair and reasonable terms and without unjust discrimination.
- b. That it will keep the airport open to all types, kinds and classes of aeronautical use without discrimination between such types, kinds, and classes. The Sponsor shall establish fair, equal and not unjustly discriminatory conditions to be met by all users of the airport as may be necessary for the safe and efficient operation.

- c. Neither it nor any person or organization occupying space at the airport will discriminate against any person or class of persons by reason of race, color, creed, or national origin in the use of the facility and, further that any person, firm or corporation rendering service to the public on the airport will do so on a fair, equal and not unjustly discriminatory basis.
- d. Operate and maintain in a safe and serviceable condition the airport and all facilities which are necessary to serve the aeronautical users and will not permit any activity which would interfere with its use for airport purposes.
- e. By acquisition of land interest, acquisition of easements, airspace zoning, or other accepted means, protect the runway approaches and the airspace in the immediate vicinity of the airport from the construction, alteration, erection or growth of any structure which would interfere with the use or operation of the airport.
- f. Comply with the New Mexico Aviation Act and associated provisions, NMSA 1978 Sections 64-1-1 to 64-5-4 and the New Mexico Municipal Airport Law, NMSA 1978 Sections 3-39-1 et seq.
- g. That it shall not award the contract nor give bidding documents to any contractor who is subject to suspension or debarment by the U.S. Department of Transportation or the Department at the time of the bidding or award of the contract. Violation of this provision shall void this Agreement.

**12. Third Party Beneficiaries.**

It is not intended by any of the provisions of any part of this Agreement to create in the public or any member thereof a third party beneficiary or to authorize anyone not a party to the Agreement to maintain a suit(s) for wrongful death(s), bodily and/or personal injury(ies) to person(s), damage(s) to property(ies), and/or any other claim(s) whatsoever pursuant to the provisions of this Agreement.

**13. New Mexico Tort Claims Act.**

As between the Department and the Sponsor, neither party shall be responsible for liability incurred as a result of the other party's acts or omissions in connection with this Agreement. Any liability incurred in connection with this Agreement is subject to the immunities and limitations of the New Mexico Tort Claims Act, NMSA 1978, Section 41-4-1, *et seq.* This paragraph is intended only to define the liabilities between the parties and it is not intended to modify, in any way, the parties' liabilities as governed by common law or the New Mexico Tort Claims Act.

**14. Scope of Agreement.**

This Agreement incorporates all the agreements, covenants, and understandings between the parties concerning the subject matter. All such covenants, agreements, and understandings have been merged into this written Agreement. No prior Agreement or understandings, verbal or otherwise, of the parties or their agents shall be valid or enforceable unless embodied in this Agreement.

**15. Terms of this Agreement.**

The terms of this Agreement are lawful; performance of all duties and obligations shall conform with and do not contravene any state, local, or federal statutes, regulations, rules, or ordinances.

**16. Equal Opportunity Compliance.**

The parties agree to abide by all federal and state laws and rules and regulations, and executive orders of the Governor of the State of New Mexico, pertaining to equal employment opportunity. In accordance with all such laws and rules and regulations, and executive orders of the Governor of the State of New Mexico, the parties agree to assure that no person in the United States shall, on the grounds of race, color, national origin, ancestry, sex, sexual preference, age or handicap, be excluded from employment with, or participation in, any program or activity performed under this Agreement. If the parties are found to not be in compliance with these requirements during the term of this Agreement, the parties agree to take appropriate steps to correct these deficiencies.

**17. Appropriations and Authorizations of State and Federal Funds.**

The terms of this Agreement are contingent upon sufficient appropriations and authorizations being made by the governing board of the Sponsor, the Legislature of New Mexico, or the Congress of the United States if federal funds are involved, for performance of the Agreement. If sufficient appropriations and authorizations are not made by the Sponsor, Legislature or the Congress of the United States if federal funds are involved, this Agreement shall terminate upon written notice being given by one party to the other. The Department and the Sponsor are expressly not committed to expenditure of any funds until such time as they are programmed, budgeted, encumbered, and approved for expenditure.

**18. Severability.**

In the event that any portion of this Agreement is determined to be void, unconstitutional or otherwise unenforceable, the remainder of this Agreement shall remain in full force and effect.

**19. Applicable Law.**

The Laws of the State of New Mexico shall govern this Agreement, without giving effect to its choice of law provisions. Venue shall be proper only in a New Mexico court of competent jurisdiction in accordance with NMSA 1978, Section 38-3-1(G).

**20. Principal Contacts and Notices.**

The principal contacts for this Agreement are listed below. Except as otherwise specified, all notices shall be in writing (including notice by facsimile or E-mail) and shall be given to the principal contacts listed below.

Address: New Mexico Department of Transportation - Aviation Division  
3501 Access Rd C.  
Albuquerque, NM 87106  
General Office: (505) 795-1401  
Fax: (505) 244-1790  
E-mail: Aviation.Division@dot.nm.gov

Name	JAMES HARRIS		
Title	AIRPORT MANAGER		
Sponsor	SANTA FE, CITY OF		
Address	PO BOX 909		
City	SANTA FE	NM	Zip Code 87504
Office Phone		Fax	
E-Mail			

**21. Amendment.**

This Agreement shall not be altered, modified, or amended except by an instrument in writing and executed by the parties.

**In witness whereof**, each party is signing this Agreement on the date stated opposite of that party's signature.

**NEW MEXICO DEPARTMENT OF TRANSPORTATION**

By: \_\_\_\_\_  
Cabinet Secretary or Designee

Date: \_\_\_\_\_

Recommended by:

By: \_\_\_\_\_  
Aviation Division Director  
or Designee

Date: \_\_\_\_\_

Approved as to form and legal sufficiency by the New Mexico Department of Transportation's Office of General Counsel

By: \_\_\_\_\_  
Assistant General Counsel

Date: \_\_\_\_\_

**SPONSOR**

Print Name: \_\_\_\_\_

By: \_\_\_\_\_

Date: \_\_\_\_\_

Title: \_\_\_\_\_

# EXHIBIT A

SANTA FE, NM

SANTA FE COUNTY MUNICIPAL AIRPORT (SAF)

SITE NO. 14728.A

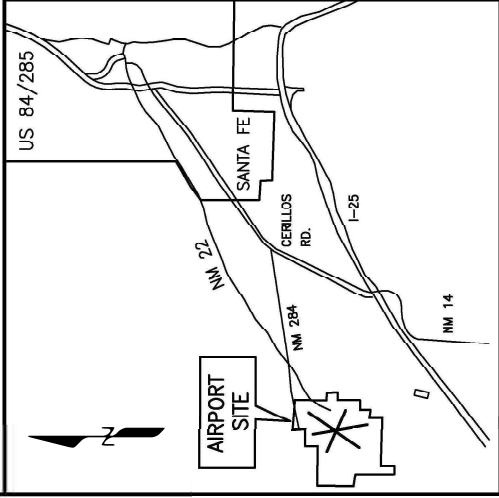

REMARKS:  
1. QUAD. - 7.5 MIN.  
TURQUOISE HILL.

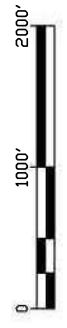
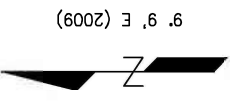
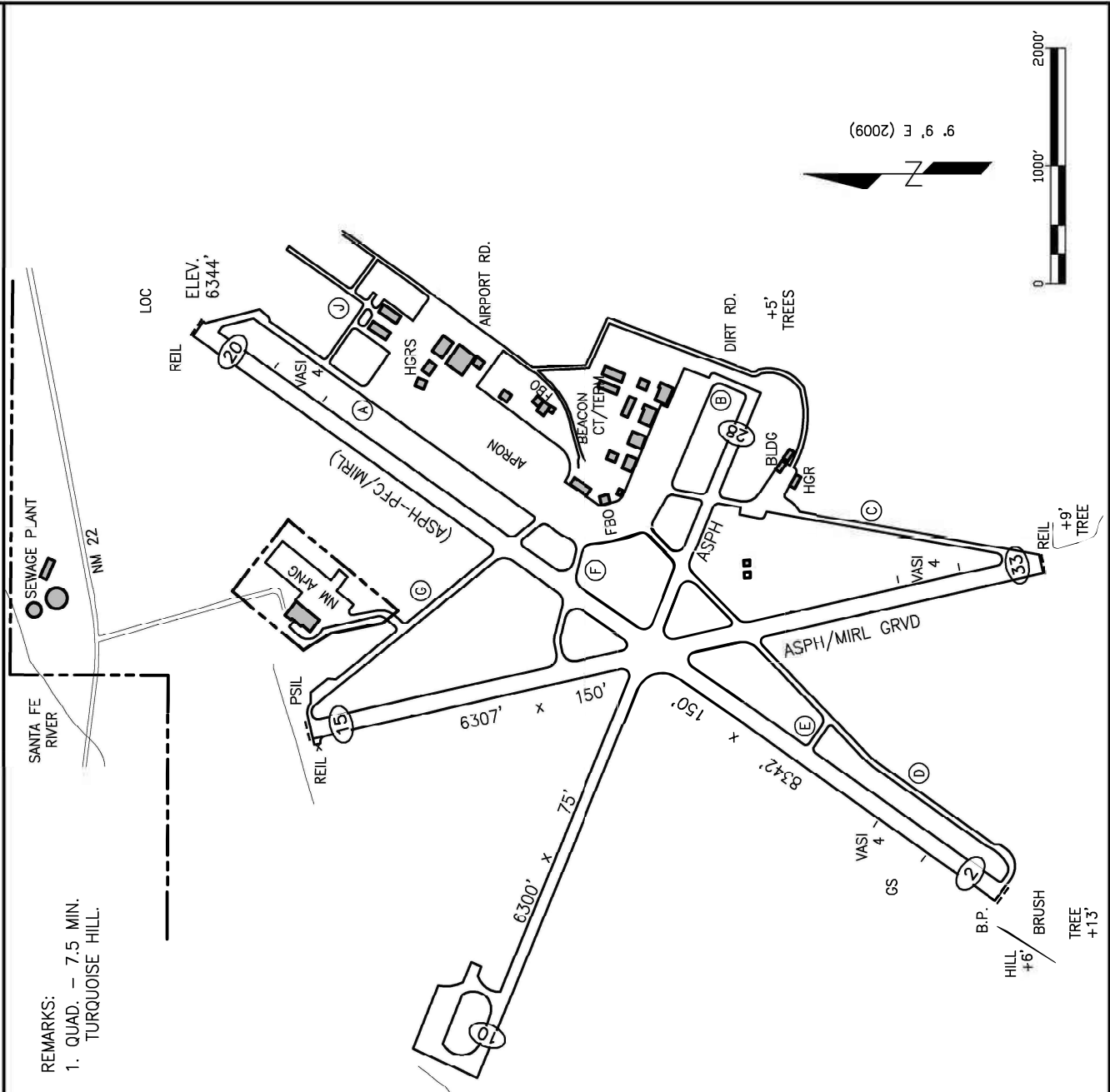

9' 9" E (2009)



IN WITNESS WHEREOF, the parties have agreed to this Grant Agreement as of the date when it is executed by the parties, whichever signature occurs last.

CITY OF SANTA FE:

\_\_\_\_\_  
ALAN WEBBER, MAYOR

DATE: \_\_\_\_\_

ATTEST:

\_\_\_\_\_  
ANDRÉA SALAZAR, CITY CLERK

CITY ATTORNEY'S OFFICE:

*Kevin L. Nault*  
Kevin L. Nault (Dec 20, 2024 09:23 MST)

ASSISTANT CITY ATTORNEY

APPROVED FOR FINANCES:

*Emily K. Oster*

\_\_\_\_\_  
EMILY OSTER, FINANCE DIRECTOR











# GB\_Grant SAF-25-02

Final Audit Report

2024-12-31

Created:	2024-12-26
By:	Kelly Bynon (kabyon@santafenm.gov)
Status:	Signed
Transaction ID:	CBJCHBCAABAArAgadJWkxH2bpfMMTkj48nwpOA-N3_IS

## "GB\_Grant SAF-25-02" History

-  Document created by Kelly Bynon (kabyon@santafenm.gov)  
2024-12-26 - 9:16:20 PM GMT- IP address: 63.232.20.2
-  Document emailed to James Harris (jcharris@santafenm.gov) for signature  
2024-12-26 - 9:18:14 PM GMT
-  Email viewed by James Harris (jcharris@santafenm.gov)  
2024-12-26 - 9:18:46 PM GMT- IP address: 63.232.20.2
-  Document e-signed by James Harris (jcharris@santafenm.gov)  
Signature Date: 2024-12-26 - 9:19:10 PM GMT - Time Source: server- IP address: 63.232.20.2
-  Document emailed to ALEXIS LOTERO (aclotero@santafenm.gov) for signature  
2024-12-26 - 9:19:11 PM GMT
-  Email viewed by ALEXIS LOTERO (aclotero@santafenm.gov)  
2024-12-27 - 0:09:01 AM GMT- IP address: 104.47.64.254
-  Document e-signed by ALEXIS LOTERO (aclotero@santafenm.gov)  
Signature Date: 2024-12-27 - 6:07:00 PM GMT - Time Source: server- IP address: 63.232.20.2
-  Document emailed to EMILY OSTER (ekoster@santafenm.gov) for signature  
2024-12-27 - 6:07:01 PM GMT
-  Email viewed by EMILY OSTER (ekoster@santafenm.gov)  
2024-12-31 - 2:32:44 PM GMT- IP address: 104.47.64.254
-  Document e-signed by EMILY OSTER (ekoster@santafenm.gov)  
Signature Date: 2024-12-31 - 2:34:29 PM GMT - Time Source: server- IP address: 50.216.119.226
-  Agreement completed.  
2024-12-31 - 2:34:29 PM GMT