

RESIDENTIAL RENOVATION – EXTERIOR COLORS

439 CAMINO DEL MONTE SOL

EASTSIDE HISTORICAL DISTRICT, SANTA FE

APRIL 07, 2025



STUCCO (SAMPLE)

**HOUSE AND YARDWALLS COLOR:
"LA LUZ #125 BY EL REY
CEMENTITIOUS COLOR-COAT**

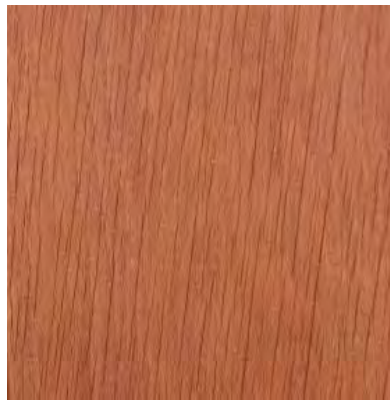

EXPOSED WOOD STAIN (STAIN SAMPLE)

**EXTERIOR DOOR COLOR:
"RED BRICK" TONE SEMI-TRANSPARENT
WOOD STAIN BY OLYMIC**

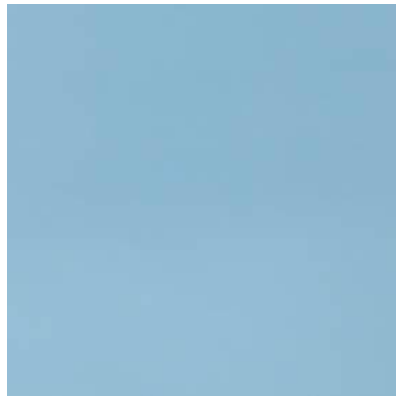

**WOOD WINDOW AND DOOR
COLOR (PAINT SAMPLE)**

**COLOR: "ANCHORS AWAY"
DE5814 BY DUNN EDWARDS**

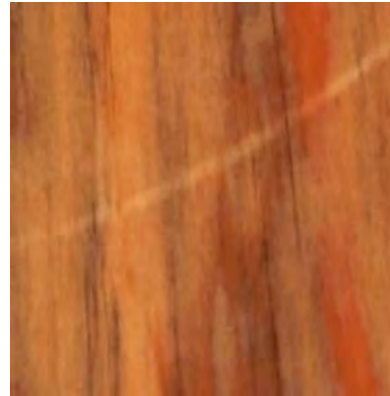

EXPOSED WOOD STAIN (SAMPLE)

**EXTERIOR VIGA COLOR:
"NATURAL CEDAR" TONE SEMI-TRANSPARENT
WOOD STAIN BY OLYMPIC**

**Existing Typical Cinco Soles Compound Garage Door
(IE: To be matched at Proposed One-Car Garage at Lot 1-A)**





116 ADOBE 24



117 FAWN 45



124 CORAL 35



125 LA LUZ 20



135 SAHARA 35



197 LA MORENA 19





★ 106 BUCKSKIN 35

107 DENIM 47

108 KOKANEE 54

DESERT ROSE 39

117 FAWN 45

121 SANDALWOOD 56

122 STRAW 42

124 CORAL 35

125 LA LUZ 20

129 IVORY 74

130 PUEBLO 53

135 SAHARA 35

197 LA MORENA 19



OLYMPIC
DECK
STAIN
BRICK
RED

ON PRESSURE
TREATED WOOD





Keep stub
for reference

DE5814 Anchors Away
LRV 44

To reorder, visit dunnedwards.com
or call (888) DE PAINT (337-2468)

Binder 5

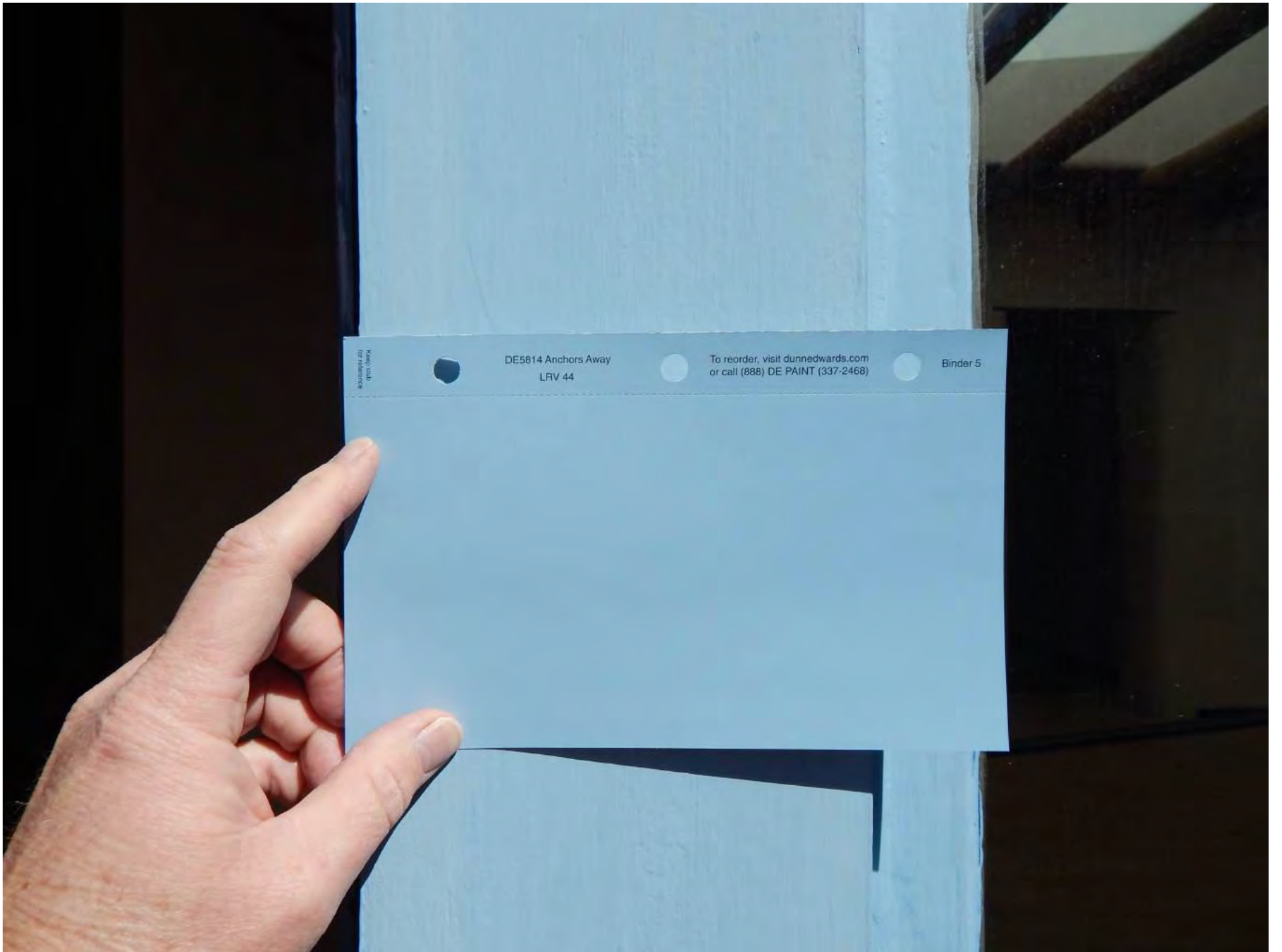

Keep this
for reference

DE5814 Anchors Away
LRV 44

To reorder, visit dunnedwards.com
or call (888) DE PAINT (337-2468)

Binder 5









WINDOW NOTES:

- ALL WINDOWS BY KOLBE, "HERITAGE COLLECTION", CRANK-OUT CASEMENTS W/ LOW E 270 INSULATED GLAZING, WOOD FRAME WITH WOOD EXTERIOR, NO METAL CLAD. PAINTED WOOD EXTERIOR TO MATCH EXISTING - SEE COLOR CHART FOR ACTUAL PAINT COLOR
- DIMENSIONS PER EXTERIOR ELEVATIONS
- DIVIDED LITES AND OPERATION PER WINDOW ELEVATIONS, TEMPERED GLASS AS CODE REQUIRES, PROVIDE SHOPS DRAWINGS FOR FINAL APPROVAL BY ARCHITECT
- WINDOWS TO BE RECESSED BACK FROM WALL PER EXTERIOR DETAIL HEREIN
- DIVIDED LITES TO BE 7/8" WITH INTERNAL SPACER BAR - SEE DETAIL

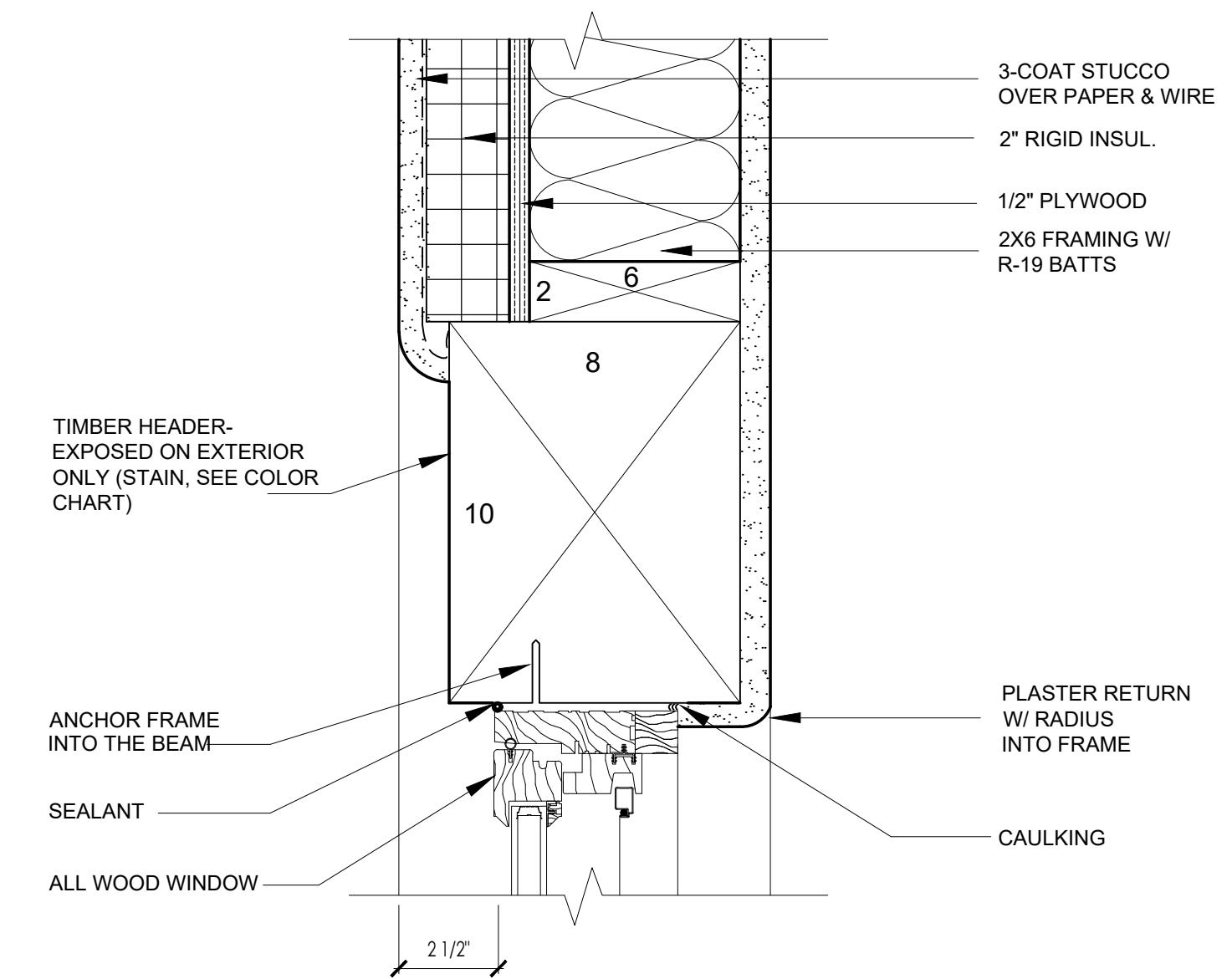

HEAD

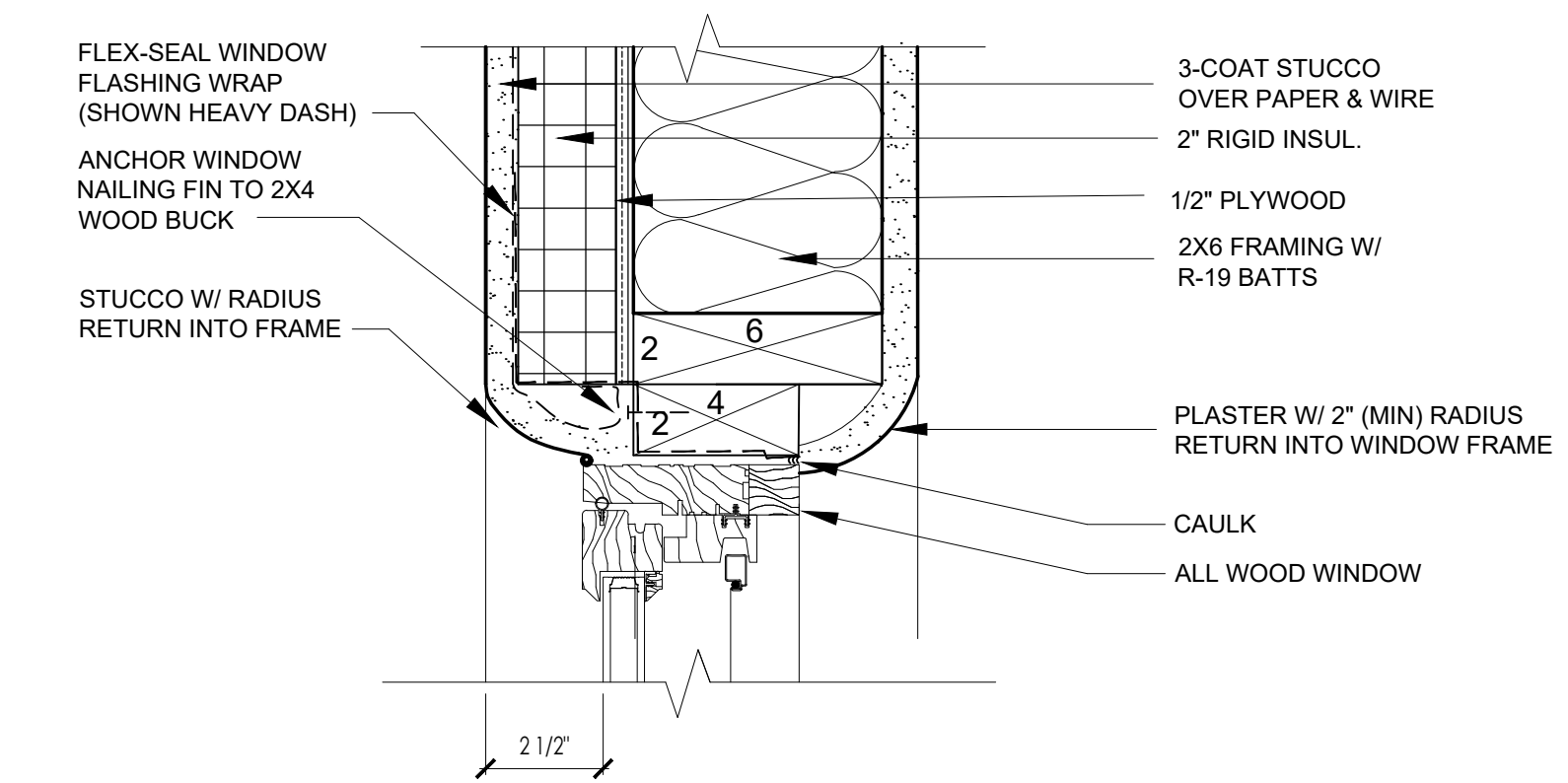

JAMB

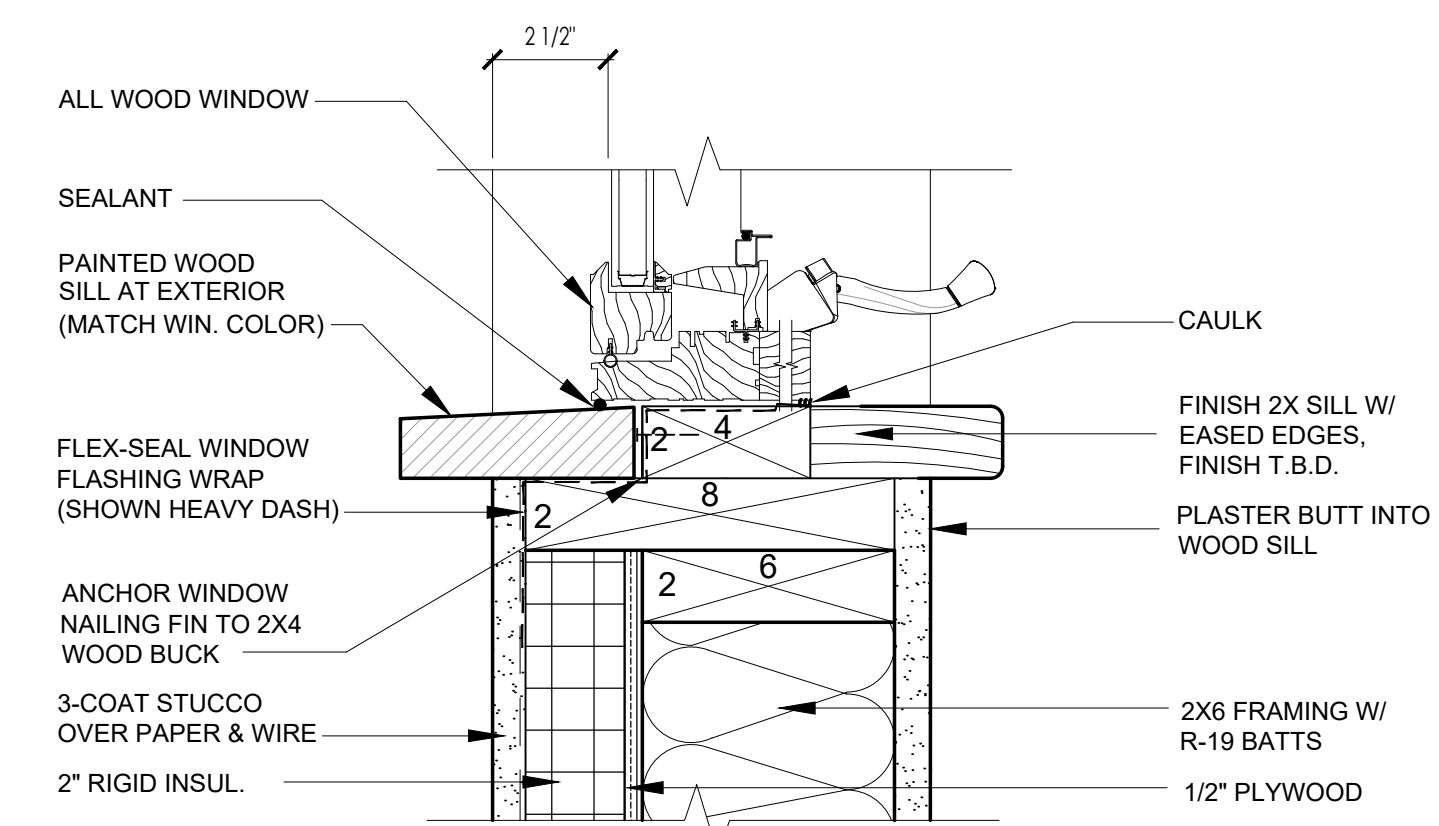

SILL

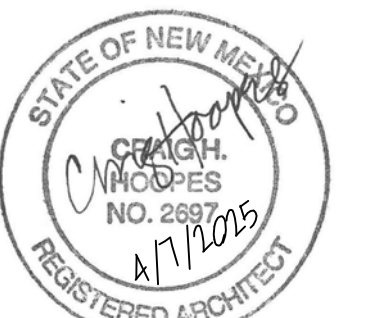

HOOPES
ARCHITECTS

333 MONTEZUMA AVE. SUITE 200
SANTA FE, NM 87501
505.966.1010
www.hoopesarchitects.com

BOLAND - GREULICH
RESIDENCE

ARCHITECT'S PROJECT NO.: 2408

439 CAMINO DEL MONTE SOL
SANTA FE, NEW MEXICO 87501

ISSUE DATE: 04.07.2025

HISTORIC APPROVAL SET
(FOR PROPOSED GARAGE)

WINDOW DETAILS

01 WINDOW DETAILS AT FRAME WALL
scale: 3" = 1'-0"

A-601

Beveled

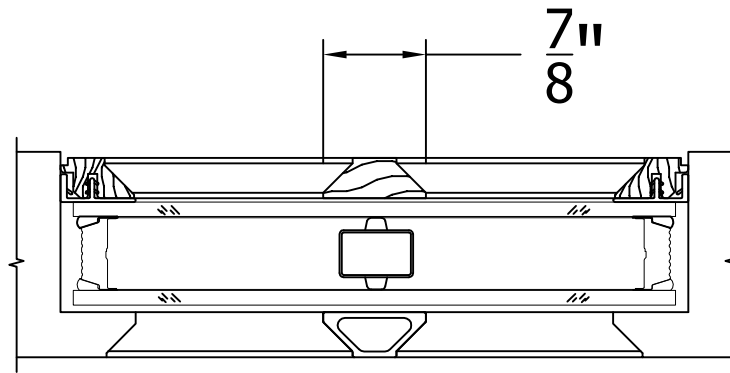

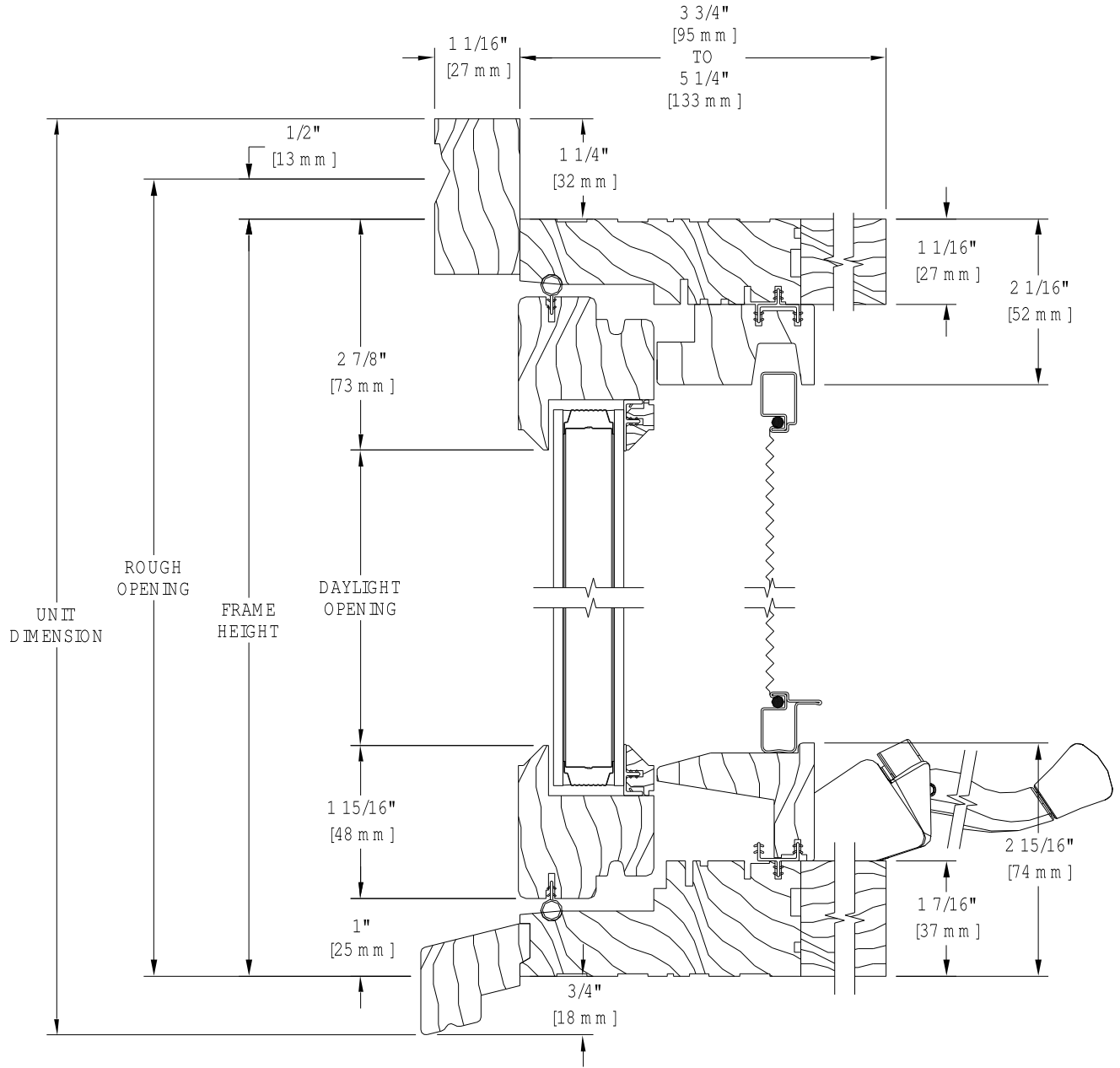

MODERN TRIM JAMB EXTENSIONS CONFIGURATION
FOR JAMB SIZES SMALLER THAN 5 5/16" TO 3 3/4"



Heritage Series



We're for the visionaries.®

**We're for people
who take building
to new levels.**



We're for people who are passionate about design, who care about the big picture and the smallest detail. We're for people who aren't satisfied with mainstream choices... who push the limits of what's possible with the options and innovations that can only be found in Kolbe windows and doors.



We're for quality craftsmanship.

We're for a tradition of excellence that outlasts the latest design trend. The Kolbe story began with a family and a vision. More than 75 years after the Kolbe brothers began their commitment to producing premium quality windows and doors, products bearing their family name can be found in some of North America's most impressive homes and businesses.

We're for expertise.

We're for people who dream of a personalized design experience. That's why you can't find Kolbe windows and doors in the aisles of a home center. Our products are only available through a Kolbe dealer, because they are as passionate about windows and doors as you are about bringing your vision to life. And they will work with you to make your dream a concrete reality.



Photo © Marre Design Group



© Darren S. Higgins

We're for possibilities.

We're for people who won't settle for "standard." We're for limitless options and custom solutions that can only be found in Kolbe's made-to-order products. Our team members are craftspeople who focus on building one window or door at a time, to create distinctive products that fulfill your unique vision.

We're for innovation.

We're for people who want to take building to new levels, with advancements in not only extraordinary sizes and shapes, but also ground-breaking products. We're for creative thinking that redefines what's possible, constantly reimagining our windows and doors to elevate style, performance and functionality.



**Let us bring
your vision
to life.**



© Kenneth M. Wyner Photography

Table of Contents

The Heritage Series	1	Traditional Double Hungs	18
Capabilities	2-7	Old World Classic Double Hungs	19
Style & Design Options	5-8	Specialty Windows	20-23
Casements	9-12	Folding Windows	21
Crank-Out Casements	10	Radius Windows	22
Push-Out Casements	11	Geometric Windows	23
Inswing Casements	12	Doors: Entrance to Expansive.....	24-28
Awnings	13-15	Sliding Doors	25
Crank-Out Awnings	14	Folding Doors	26
Push-Out Awnings	15	Inswing Doors	27
Double Hungs	16-19	Outswing Doors	28
Sterling Double Hungs	17	Professional Tools	29

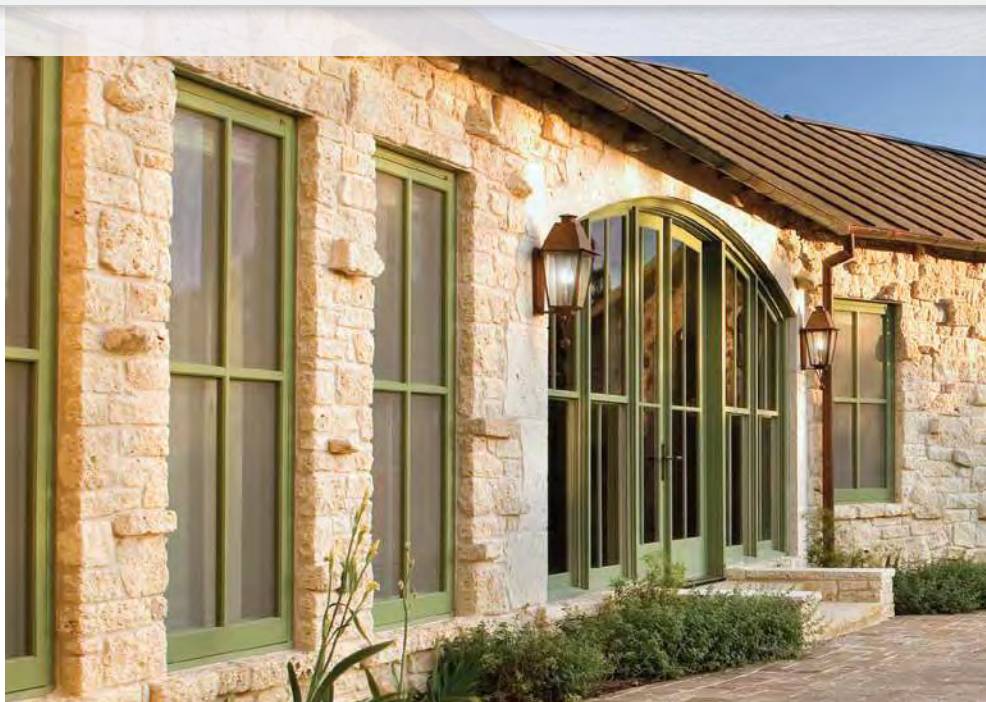



© Kenneth M. Wyner Photography

The Heritage Series

All-wood windows & doors designed for architectural & historical authenticity.

Kolbe's Heritage Series windows and doors are carefully crafted with a wood interior and exterior, making it possible to replicate architectural details with authenticity and alignment with historic district requirements. Choose from an extensive array of exterior colors, interior wood species, finishes, divided lite profiles, and more.

The Heritage Series provides:

- Wood exterior available in unfinished, primed, or painted with our K-Kron II finish, for ultimate flexibility
- High performance exterior K-Kron II finish in 40+ standard colors, plus custom blends
- Wood interior in familiar to exotic species, with 20+ standard pre-finishes, plus custom finishes
- Traditional design aesthetics with ability to replicate intricate architectural details
- Divided lite profiles & patterns
- Glazing options for enhanced energy efficiency, decorative & specialty glass needs
- Hardware options & finishes to match any décor
- Automation options for ease of operation



© Marre Design Group

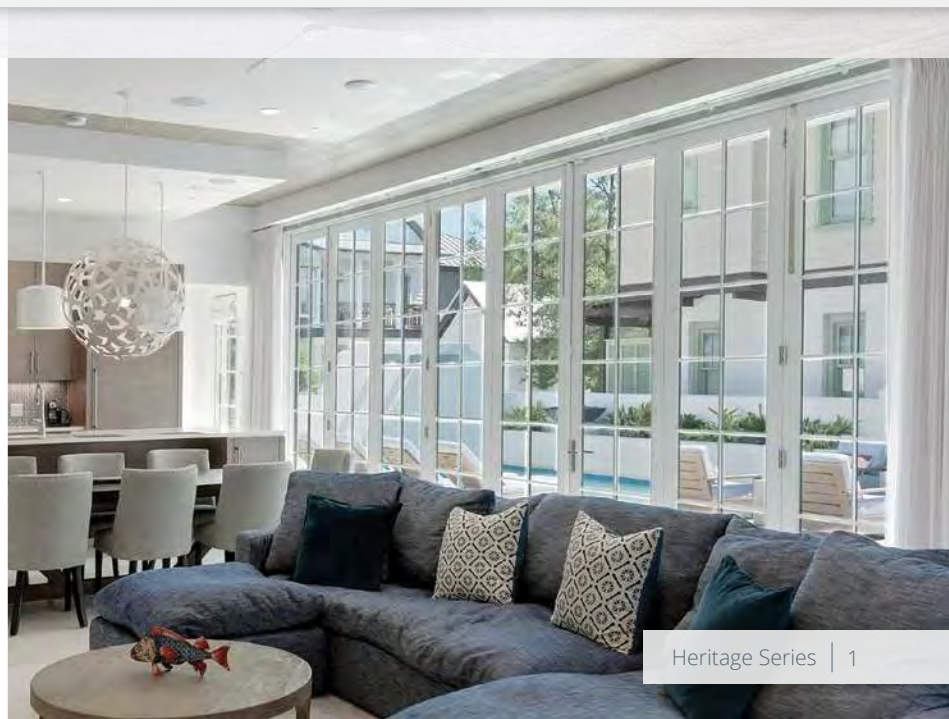



© Scot Hill Photography

Capabilities

Craftsmanship and artistry are hallmarks of Kolbe products. We build innovative windows and doors with a wide array of options. But don't let the standard options limit your imagination.

At Kolbe, we love a good challenge. We welcome projects that require special wood species, custom divided lite patterns, unique shapes, custom finish colors, unusual mulling configurations – you dream it, we'll build it. Our windows and doors are built to order, so you can choose the options that best suit your design and vision. We offer multiple product lines with distinct characteristics and a full breadth of capabilities for customization and personalization.

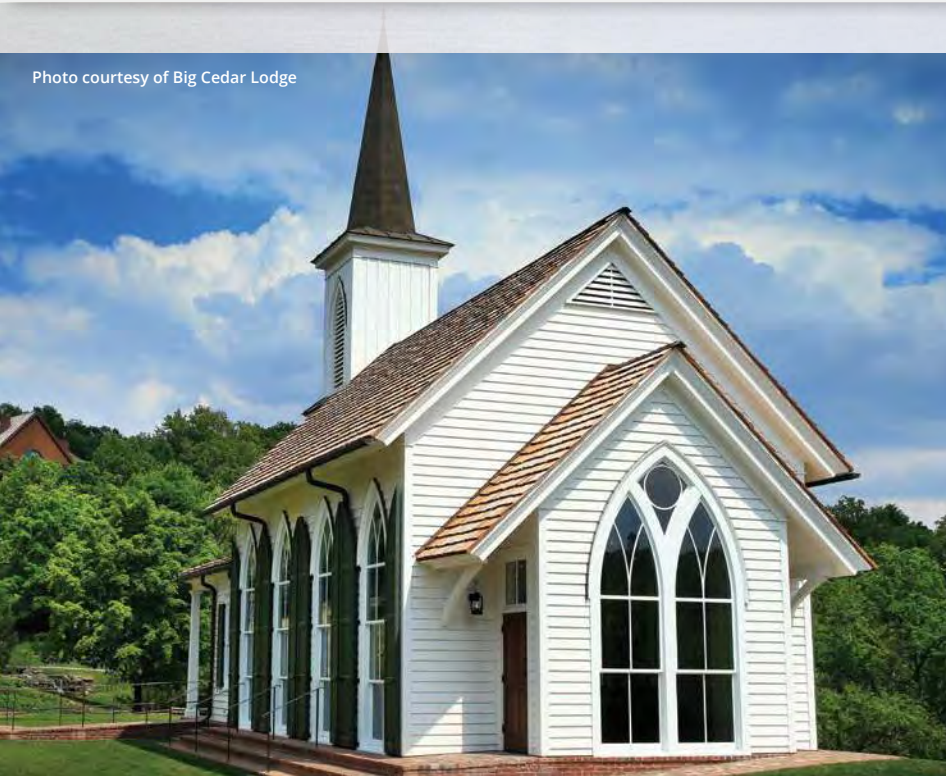
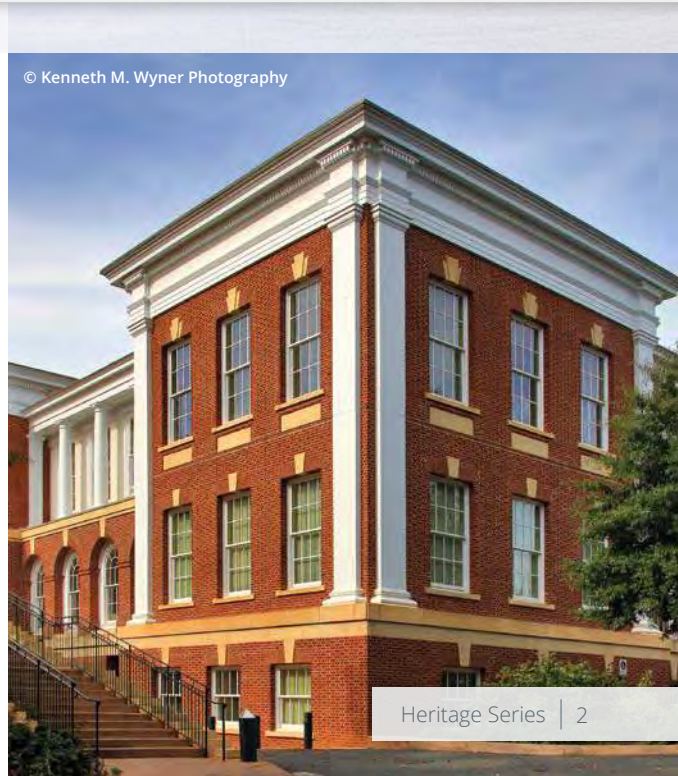

Photo courtesy of Big Cedar Lodge



© Kenneth M. Wyner Photography

Capabilities

Energy Efficiency

In addition to superior craftsmanship, Kolbe windows and doors offer superior performance. Our products undergo independent testing to ensure the highest quality available. Participation in the Window & Door Manufacturers Association (WDMA) Hallmark Certification and ENERGY STAR® programs ensures that our products are tested to industry standards, allowing them to meet and exceed today's stricter building codes and standards for energy efficiency.

Kolbe's Heritage Series windows and doors can meet the strict California Title 24 Building Energy Efficiency Standards. Talk to your Kolbe dealer about specific products with glass options that help meet these stringent energy efficiency requirements.



Sustainability

Kolbe's all-wood Heritage Series windows and doors offer sustainable solutions for long-lasting, durable products that have a lower carbon footprint than other building materials. Prioritizing resilient design, supported with high-performance products, makes Heritage Series a great choice for the environment.

Our wood species are renewable resources sourced from managed forests, and our standard glass contains 25-30% recycled content. We can also provide The Forest Stewardship Council® (FSC®)-certified wood species for many products (FSC® license code FSC®-C019541).



For energy performance data, visit: kolbewindows.com/energy

Kolbe demonstrates a commitment to providing accurate energy data by having products independently simulated, tested, inspected and listed in the NFRC certification program, and making that data available at kolbewindows.com and on window labels.

Energy performance data and air, water, structural data is updated on a continuous basis.

For the most current information, contact your local Kolbe dealer.

Kolbe® has been granted The Forest Stewardship Council® (FSC®) Chain-of-Custody Certification, as have many of our dealers. Consult with your dealer about using FSC®-certified wood in your project (FSC® license code FSC®-C019541).

Capabilities

Craftsmanship

Kolbe products are truly built to order, with numerous options and custom solutions that allow us to craft windows and doors exactly to your specifications. You can choose from standard to exotic wood species, sizes, shapes, divided lite profiles and patterns, glass, interior and exterior finishes, brickmoulds, casings, hardware, and more – or we'll work with you to create a custom product, color or finish for a more personalized design.



Historical Replication

Heritage Series all-wood products are ideal for replicating architectural details with authenticity, blending traditional design aesthetics with advanced technology, functionality, and optimal energy efficiency. Adhering to strict building codes and historical district requirements, Kolbe's Heritage Series products were the perfect solution for many National Historic Landmarks and National Trust for Historic Preservation projects across the US.



Style & Design Options

Kolbe offers distinctive style and design options, to make your spaces unique. For the ultimate in personalization, choose from our numerous options, including hardware, glass, divided lites, screens, sills, exterior trim, and more – plus custom solutions to help bring your unique vision to life.

Hardware

Kolbe offers numerous hardware styles and finishes to complement décor or add the finishing touch to a new entrance, sliding or access door. Plus, the added functionality of multi-point locks and automation options on select products adds convenience and security to your living experience. For replicating historic details, chain and pulley systems and spoon locks are available for double hung windows.

Glass

There is so much more to glass than visibility. It can add to the aesthetic, enhance indoor comfort and acoustics, provide privacy or decorative design. When considered holistically, windows and doors can help create environments that offer a sense of well-being and a connection to nature. Kolbe's numerous glass options provide optimum energy efficiency, beauty and performance to enhance your design as well as your lifestyle.

Divided Lites

Add architectural detail to windows and doors with performance divided lites (PDL) or true divided lites (TDL). Choose anything from a traditional, Colonial style pattern to a custom design that accentuates the character and appearance of your home. True divided lites are ideal for historic restoration projects, creating individual panes of glass to mimic original design details. Grilles-in-the-airspace and interior removable wood grilles are also available.



Finish Options

Interior Wood Species

In addition to the standard pine, Heritage Series windows and doors can be constructed of other optional wood species that enhance their look. Pine and other wood species are sourced from managed forests. The Forest Stewardship Council® (FSC®)-certified wood species are also available for green building projects (FSC® license code FSC®-C019541).

Ask about the availability of additional wood species.



Interior Finishes

For units that are ready to install upon delivery, Kolbe's Heritage Series windows and doors can be prefinished on the interior with one of the water-based stains or paints shown. Stained units are given two coats of satin clear finish. Because our interior finishes are water-based, low-VOC stains and paints, you can rest assured you've made an environmentally conscious decision. Custom colors may be requested as well.



Priming options available upon request.



*Applied as a single coat of paint, with some visible wood grain.

Some options for our products may have limited color offerings or may incur a nominal charge. Check with your Kolbe dealer for further details on pricing and availability. Stain colors are shown on pine. A double coat clear finish is also offered. Since no two trees are identical, wood can be expected to differ both in color and graining. These factors will influence the stain's final color.

Printed images of wood species and stain options will vary from actual product colors. Selections should be made based on color samples available from your Kolbe dealer.

Color-matched interior paint is available through any Sherwin-Williams retail store's National Account System in the United States and Canada.

Finish Options

Exterior Colors

Most Heritage Series windows and doors are coated on the exterior with latex primer, ready for your choice of topcoat. Kolbe also offers K-Kron II – a durable exterior finish that enhances and preserves the look of wood windows and doors.

				White	Cloud	Ultra Pure White
				Abalone	Alabaster	Camel
Mudpie	Nutmeg	Khaki	Sahara	Beige	Natural Cotton	Spiced Vinegar
Gingersnap	Truffle	Rustic	Shadow	Shale	Smokestack	Timberwolf
Sapphire	Coastal Storm	Lunar	Steel Gray	Slate	Castlerock	Emerald Isle
Cider	Copper Canyon	Basil	Mystic Ivy	Mediterranean	Green Tea Leaf	Hartford Green
Chutney	Roma	Maize	Custom Colors Available			

Wire Brush Finish

Most of Kolbe's Heritage Series wood windows and doors can be further enhanced by our custom wire brush finish. Wire brushing creates a rugged texture and adds character to complement any rustic design.

Due to the nature of the finishes, certain limitations apply. Contact your local Kolbe dealer for more information.



Some options for our products may have limited color offerings or may incur a nominal charge. Check with your Kolbe dealer for further details on pricing and availability.

Printed images of exterior finishes may vary slightly from actual colors. Selections should be made based on color samples available from your Kolbe dealer.

Accessories

Brickmould & Casing

Accentuate the beauty of your home with Kolbe's exterior brickmoulds and casings. In addition to the casings shown, various sill nosings can be applied to enhance the overall appearance and to create the perfect look. Custom brickmoulds and casings are available as well; talk to your local Kolbe dealer for more information.

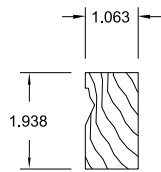

1-15/16" brickmould

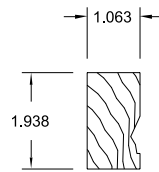

1-15/16" flat casing

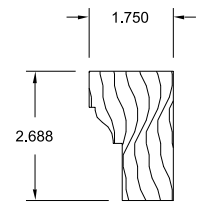

1-15/16" flat casing with backband

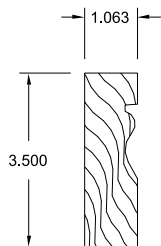
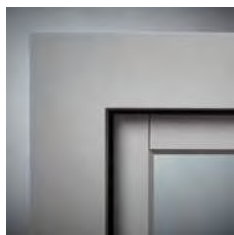

3-1/2" flat casing

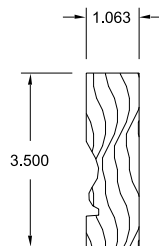

3-1/2" profiled brickmould

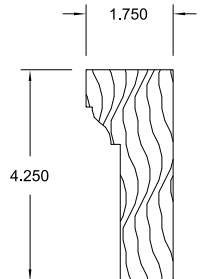
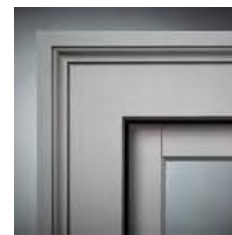

3-1/2" flat casing with backband

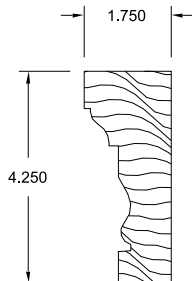

3-1/2" profiled brickmould with backband

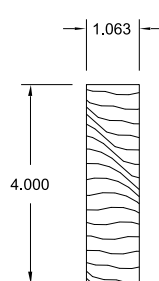
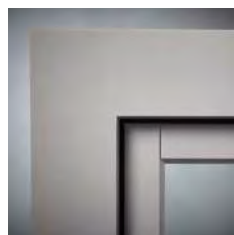

4" flat casing

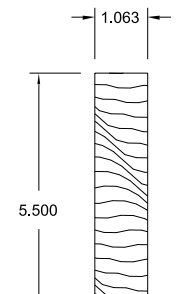
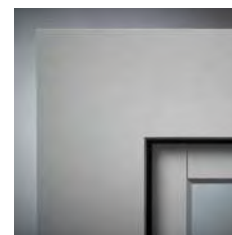

5" flat casing

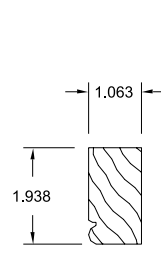

2" beaded casing

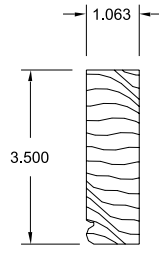
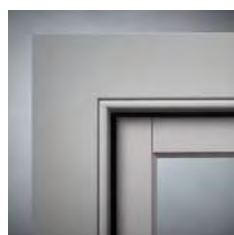

3-1/2" beaded casing

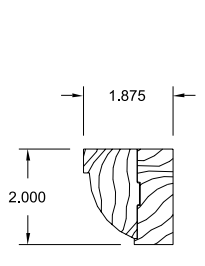
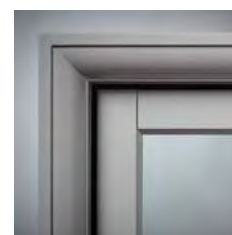

Prospect casing

NOTES: Limitations apply when combining trim options. Not all brickmould profiles are available for all products. Not all profiles are available for radius units. Please consult your local Kolbe dealer for more information.



[Click to view more: kolbewindows.com/gallery](http://kolbewindows.com/gallery)

Casements

Offering ventilation and plenty of daylight, Heritage Series casements provide excellent energy efficiency. Easy-to-operate handles, corrosion-resistant hardware, and a secure, concealed multi-point locking system on most products contribute to the integrity of these windows. A multitude of styles are available, including French, push-out, inswing, segment head and half-circle top casements.

*Crank-Out Casements | Push-Out Casements | Inswing Casements | French Casements | Picture & Transom Units
Picture Combination Units | Bow & Bay Units | Segment Head & Half-Circle Top Units*



Crank-Out Casements

Kolbe's crank-out casements combine a simple cranking operation with many options for customization. Swinging out at the side to provide fresh air and ventilation, they close easily and effectively with a tight seal. Crank handles fold down when not in use to prevent interference with window treatments and views.



Standard Features – Crank-Out Casement

- ▶ 1-3/4" thick sash
- ▶ Overall jamb depth is 4-9/16"
- ▶ Constructed of pine, with pine interior stops and wood mull casings on mull units
- ▶ Energy efficient, insulating Solar Low-E glass
- ▶ Glazed to the interior with beveled wood glazing beads
- ▶ 1-15/16" exterior brickmould applied
- ▶ Exterior wood parts are treated
- ▶ Exterior frame and sash are latex primed
- ▶ Interior screens with Clay-colored aluminum frames and BetterVue® fiberglass mesh
- ▶ Clay-colored nesting handles, operator covers and multi-point locks* (lock handles match operator handle colors)
- ▶ Corrosion-resistant dual-arm operators with concealed, adjustable hinges *(single-arm operators with concealed, adjustable hinges on "S" Series casements; single-arm operators with Euro hinges for added support on segment head and half-circle top units)*

Options – Crank-Out Casement *(not all options are available on all casement types; custom options are also available)*

- ▶ K-Kron II exterior paint finish
- ▶ French casements
- ▶ Interior casing
- ▶ Prep for stool
- ▶ Exterior brickmould and casing *(pg. 8)*
- ▶ Projected sill nosing, extended sill horns or no sill nosing
- ▶ Universal design handle and lock in White or Clay
- ▶ Motorized window system
- ▶ Single-arm operators with Euro hinges
- ▶ Extension jambs *(up to 12" applied; over 12" shipped loose for field application)*
- ▶ Galvanized steel installation clips
- ▶ Retractable screen kit; beveled *(standard)* or square retractable screen covers; wood-wrapped screens *(not available on radius top or "S" series units)*; screens with aluminum or UltraVue® fiberglass mesh and wood frame
- ▶ Bow and bay options: insulated platforms, support brackets and oak-veneered head and seat boards
- ▶ High performance modifications
- ▶ Field-applied Window Opening Control Device (WOCD)

NOTE: All measurements are nominal.
BetterVue® and UltraVue® are registered trademarks of PHIFER INCORPORATED.
* Not available on French casements.

Push-Out Casements

Kolbe's push-out casements have a uniquely simple operation. Simply unlock a handle to push open or pull closed. Combining ease-of-operation with authentic style, push-out casements offer Old World aesthetics with today's energy efficiency.



Standard Features – Push-Out Casement

- ▶ 1-3/4" thick sash
- ▶ Overall jamb depth is 4-9/16" (*basic box depth is 3-1/2" plus extensions*)
- ▶ Constructed of pine, with pine interior stops and wood mull casings on mull units
- ▶ Energy efficient, insulating Solar Low-E glass
- ▶ Glazed to the interior with beveled wood glazing beads
- ▶ 1-15/16" exterior brickmould applied
- ▶ Exterior wood parts are treated
- ▶ Exterior frame and sash are latex primed
- ▶ Single-point lever handle in an Oil-Rubbed* finish
- ▶ Concealed hinges (*segment head and half-circle top units use Tri-Euro hinges for added support*)

Options – Push-Out Casement *(not all options are available on all casement types; custom options are also available)*

- ▶ K-Kron II exterior paint finish
- ▶ French push-out casements
- ▶ Interior casing
- ▶ Prep for stool
- ▶ Exterior brickmould and casing (*pg. 8*)
- ▶ Projected sill nosing, extended sill horns or no sill nosing
- ▶ Extension jambs (*up to 12" applied, over 12" shipped loose for field application*)
- ▶ Galvanized steel installation clips
- ▶ Wood frame hinged/swinging screen or retractable screen with BetterVue® fiberglass mesh (*segment head and half-circle top casements are only available with a hinged/swinging screen*)
- ▶ Retractable screen covers available as beveled (*standard*) or square; screens with UltraVue® fiberglass mesh (*hinged/swinging screen only*)
- ▶ High performance modifications
- ▶ Field-applied Window Opening Control Device (WOCD)

NOTE: All measurements are nominal.
BetterVue® and UltraVue® are registered trademarks of PHIFER INCORPORATED.
* The Oil-Rubbed finish is a living finish, which means that it will change appearance over time with use.

Inswing Casements

Kolbe's inswing casements are inspired by classic French design with modern updates to meet energy efficiency standards, proving it's possible to honor traditionally beautiful design while making a modern architectural statement. Inswing casements open inward for ventilation and are available in single or French units.



Standard Features – Inswing Casement

- ▶ 1-3/4" thick sash
- ▶ Bottom rail height is 3-1/2"
- ▶ Overall jamb width is 4-9/16"
- ▶ Constructed of pine, with pine interior stops and wood mull casings on mull units
- ▶ 1-15/16" exterior brickmould applied
- ▶ Exterior wood parts are treated
- ▶ Exterior frame and sash are latex primed
- ▶ Energy efficient, insulating Solar Low-E glass
- ▶ Glazed to the interior with beveled wood glazing beads
- ▶ Multi-point locking hardware secures the unit
- ▶ Bright Brass handle set as standard
- ▶ Sash hang on 3-1/2" x 3-1/2" butt hinges in a Bright Brass finish
- ▶ Exterior screens with BetterVue® fiberglass mesh and aluminum screen frames in a variety of colors
- ▶ A drip-lip applied to the bottom exterior of the sash and a weep channel system on the sill

Options – Inswing Casement (not all options are available on all casement types; custom options are also available)

- ▶ K-Kron II exterior paint finish
- ▶ French inswing casements
- ▶ Interior casing
- ▶ Prep for stool
- ▶ Exterior brickmould and casing (pg. 8)
- ▶ Projected sill nosing, extended sill horns or no sill nosing
- ▶ Extension jambs (up to 7")
- ▶ Screens to match exterior color; screens with aluminum or UltraVue® fiberglass mesh
- ▶ Galvanized steel installation clips



Click to view more: kolbewindows.com/gallery

Awnings

Heritage Series awning windows open outward from the bottom, so they are fully functional even when there is a gentle rain outside. Awnings offer unique style and architectural interest to any room, and are the perfect complement to other Kolbe® windows and doors. Nesting handles and dual-arm operators make these windows easy to operate, with additional light and ventilation..

Crank-out Awnings | Push-out Awnings | Picture Units | Picture Combination Units | Muller Configurations



© Scot Hill Photography

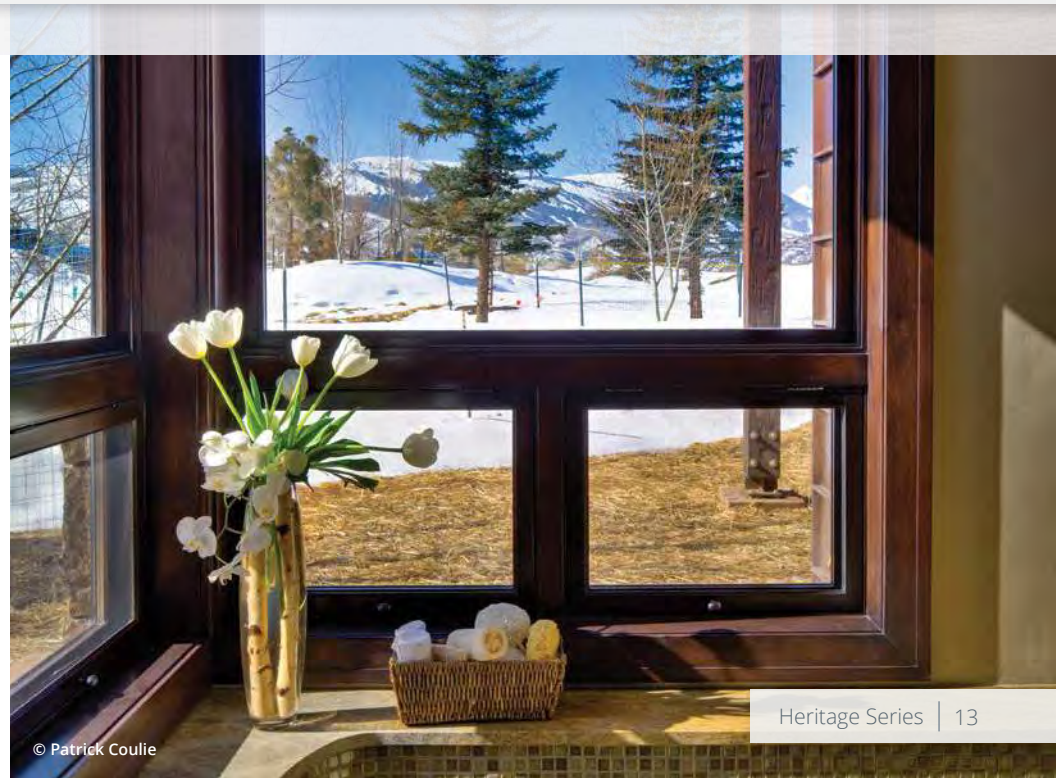

© Patrick Coulie

Crank-Out Awnings

Crank-out awnings open outward from the bottom with a crank handle that folds down when not in use. Choose motorized operators for an effortless way to open and close your window, especially when it's in a hard-to-reach place.



Standard Features – Crank-Out Awning

- ▶ 1-3/4" thick sash
- ▶ Overall jamb depth is 4-9/16" (*basic box width is 3-1/2"*)
- ▶ Constructed of pine, with pine interior stops and wood mull casings on mullied units
- ▶ Exterior wood parts are treated
- ▶ 1-15/16" exterior brickmould applied
- ▶ Exterior frame and sash are latex applied
- ▶ Energy efficient, insulating Solar Low-E glass
- ▶ Glazed to the interior with beveled wood glazing beads
- ▶ Interior insect screen with Clay-colored aluminum frame and BetterVue® fiberglass mesh
- ▶ Clay-colored nesting handles, operator covers and multi-point locks
- ▶ Folding corrosion resistant operators with concealed, adjustable hinges

Options – Crank-Out Awning *(custom options are also available)*

- ▶ K-Kron II exterior paint finish
- ▶ Interior casing
- ▶ Prep for stool
- ▶ Exterior brickmould and casing (*pg. 8*)
- ▶ Projected sill nosing, extended sill horns or no sill nosing
- ▶ Universal design handle and lock in White or Clay
- ▶ Motorized window system
- ▶ Screens with White, Beige, Sand, Dark Bronze Anodized, Clear Anodized, or Coal Black frames
- ▶ Screens with aluminum or UltraVue® fiberglass mesh
- ▶ Wood wrapped screens; retractable screen kit; beveled retractable screen covers (*standard*) or square
- ▶ Extension jambs (*up to 12" applied; over 12" shipped loose for field application*)
- ▶ Galvanized steel installation clips
- ▶ High performance modifications

Push-Out Awnings

The simple operation of push-out awning windows makes them ideal for adding ventilation to any room. The sash pushes out and pulls in tightly to the frame. Weatherstripping prevents air infiltration, making them another great energy-efficient option.



Standard Features – Push-Out Awning

- ▶ 1-3/4" thick sash
- ▶ Overall jamb depth is 4-9/16" (*basic box depth is 3-1/2" plus extensions*)
- ▶ Constructed of pine, with pine interior stops and wood mull casings on mullied units
- ▶ 1-15/16" exterior brickmould applied
- ▶ Exterior wood parts are treated
- ▶ Exterior frame and sash are latex primed
- ▶ Energy efficient, insulating Solar Low-E glass
- ▶ Glazed to the interior with beveled wood glazing beads
- ▶ Single-point lever handle in an Oil-Rubbed* finish
- ▶ Concealed hinges (*segment head and half-circle top units use Tri-Euro hinges for added support*)

Options – Push-Out Awning (*custom options are also available*)

- ▶ K-Kron II exterior paint finish
- ▶ Interior casing
- ▶ Prep for stool
- ▶ Exterior brickmould and casing (*pg. 8*)
- ▶ Projected sill nosing, extended sill horns or no sill nosing
- ▶ Extension jambs (*up to 12" applied, over 12" shipped loose for field application*)
- ▶ Wood frame hinged/swinging screen or retractable screen with BetterVue® fiberglass mesh (*segment head and half-circle top casements are only available with a hinged/swinging screen*)
- ▶ Beveled (*standard*) or square retractable screen covers
- ▶ Screens with UltraVue® fiberglass mesh (*hinged/swinging screen only*)
- ▶ Galvanized steel installation clips
- ▶ High performance modifications

NOTE: All measurements are nominal.
BetterVue® and UltraVue® are registered trademarks of PHIFER INCORPORATED.
* The Oil-Rubbed finish is a living finish, which means that it will change appearance over time with use.



Photo provided by North Atlantic Corp.

[Click to view more: kolbewindows.com/gallery](https://kolbewindows.com/gallery)

Double Hungs

Kolbe offers a variety of double hung windows for residential or commercial projects, from historic restoration to remodeling. Quality details adorn the classic design of Heritage Series all-wood double hungs, with smooth operation, venting options, and removable sash for easy cleaning. There are many options and configurations to choose from, including cottage-style and radius-topped units or triple pane glass options for increased energy efficiency.

*Sterling Double Hungs | XL Sterling Double Hungs | Traditional Double Hungs
Old World Classic Double Hungs | Cottage-Style & Reverse-Cottage Style | Studio & Transom Units
Picture Combination Units | Segment Head & Half-Circle Top Units | Single Hungs*



Sterling Double Hungs

Whether residential or commercial, Sterling double hungs are made to blend seamlessly with the grandest décor. A patented interior wood cover conceals the jambliner, giving the windows a rich, all-wood appearance. The XL Sterling double hung offers a boost in performance and enhances the architectural design with oversized openings.



© Puliatti Photographic



© Ryann Ford Photography

Standard Features – Sterling Double Hung

- ▶ 1-3/4" thick sash
- ▶ Overall jamb width is 4-9/16" (*basic box width is 4-9/16"*)
- ▶ Frame thickness is 3/4" at side jambs and head
- ▶ Sill thickness is 1-3/16", slope is 14°
- ▶ Constructed of pine, with pine interior stops and wood mull casings on mull units
- ▶ Energy efficient, insulating Solar Low-E glass
- ▶ Glazed to the interior with beveled wood glazing beads
- ▶ 1-15/16" exterior brickmould applied
- ▶ Exterior wood parts are treated
- ▶ Exterior frame and sash are latex primed
- ▶ Wood interior head parting stop
- ▶ Clay-colored heavy duty Signature sash lock with a dual positioning lever allows sash to be unlocked, operated and tilted in from one location
- ▶ Spring-loaded block-and-tackle mechanical balances to carry the sash weight
- ▶ Concealed balance system
- ▶ Wood-wrapped jambliner closure on the interior (*unless interior is prefinished white or primed, then jambliner will be white*) and a primed, extruded aluminum jambliner closure on the exterior hides balance system

Standard Features – XL Sterling Double Hung (*includes Sterling double hung standard features, with the exception of the following substitutions:*)

- ▶ Overall jamb depth is 5" (*basic box depth is 5"*)
- ▶ Class 5 balances capable of carrying heavier loads

Options – Sterling Double Hung/XL Sterling Double Hung (*custom options are also available*)

- ▶ K-Kron II exterior paint finish
- ▶ Interior casing
- ▶ Prep for stool
- ▶ Exterior brickmould and casing (*pg. 8*)
- ▶ Projected sill nosing, extended sill horns or no sill nosing
- ▶ Class 5 balances available for commercial specifications or larger units
- ▶ Universal design crank handle hardware kit in White
- ▶ Extension jambs (*up to 12" applied, over 12" shipped loose for field application*)
- ▶ Sash limiters for safety
- ▶ Galvanized steel installation clips
- ▶ Full or half aluminum frame insect screen with aluminum, BetterVue® or UltraVue® fiberglass mesh; retractable insect screen kit with beveled or square cover
- ▶ Factory-installed Window Opening Control Device (WOCD)
- ▶ Segment head, cottage style segment head, half-circle top, and cottage style half-circle top units
- ▶ High performance modifications

NOTE: All measurements are nominal.
BetterVue® and UltraVue® are registered trademarks of PHIFER INCORPORATED.

Traditional Double Hungs

Kolbe's traditional double hungs offer classic styling, with a sloped sill to help guard against water damage. Available as cottage-style units or radius-top shapes, traditional double hungs open and close smoothly and effortlessly, with a tilt-in or removable sash for easy cleaning.



Standard Features – Traditional Double Hung

- ▶ 1-3/8" thick sash
- ▶ Overall jamb depth is 4-9/16" (*basic box depth is 4-9/16"*)
- ▶ Frame thickness is 3/4" at side jambs and head
- ▶ Sill thickness is 1-3/16"; slope is 14°
- ▶ Constructed of pine, with pine interior stops and wood mull casings on mullied units
- ▶ 1-15/16" exterior brickmould applied
- ▶ Exterior wood parts are treated
- ▶ Exterior frame and sash are latex primed
- ▶ Energy efficient, insulating Solar Low-E glass
- ▶ Glazed to the interior with beveled wood glazing beads
- ▶ Rigid PVC head parting stop with flexible fins and waterseal at the sill
- ▶ Clay-colored heavy duty sash lock
- ▶ Machined finger grooves on the top rail of the upper sash and bottom rail of the lower sash
- ▶ Spring-loaded block-and-tackle mechanical balances to carry the sash weight
- ▶ Beige PVC jambliners with compression foam backing

Options – Traditional Double Hung *(custom options are also available)*

- ▶ K-Kron II exterior paint finish
- ▶ Interior casing
- ▶ Prep for stool
- ▶ Exterior brickmould and casing (*pg. 8*)
- ▶ Projected sill nosing, extended sill horns or no sill nosing
- ▶ No finger grooves in top, bottom or both sash
- ▶ White jambliners
- ▶ Extension jambs (*up to 12" applied, over 12" shipped loose for field application*)
- ▶ Full or half screens with aluminum frames and options for BetterVue® or UltraVue® fiberglass screen mesh or aluminum screen mesh; frames will match the exterior color of the unit
- ▶ Factory-installed Window Opening Control Device (WOCD)
- ▶ Sash limiters for safety
- ▶ Galvanized steel installation clips

Old World Classic Double Hungs

Old World Classic double hungs bear the charm and character of early double hung windows. Ideal for historically-accurate replication projects, their visible brass pulley system with solid brass chains and alloyed weights accentuates the design details, while allowing fluid operation. Specifically engineered for each unique project, Old World Classic windows offer an unprecedented level of customization – even as triple hungs, radius-tops, and cottage-style units.



Standard Features – Old World Classic Double Hung

- ▶ 1-3/4" thick sash
- ▶ Basic frame jamb width is 6-9/16"
- ▶ Constructed of pine with pine interior head parting stops and side stops
- ▶ Energy efficient, insulating Solar Low-E glass
- ▶ 1-15/16" exterior brickmould applied
- ▶ Exterior wood parts are treated
- ▶ Exterior frame and sash are latex primed
- ▶ Heavy duty sash lock with Antique Brass finish
- ▶ Brass chains and pulleys
- ▶ A proportionate balance between sash and alloyed weights creates a one-to-one ratio

Options – Old World Classic Double Hung *(custom options are also available)*

- ▶ K-Kron II exterior paint finish
- ▶ Interior casing
- ▶ Prep for stool
- ▶ Exterior brickmould and casing *(pg. 8)*
- ▶ Projected sill nosing, extended sill horns or no sill nosing
- ▶ Available as single, double or triple hung
- ▶ Ogee lugs integrated into the top sash stiles
- ▶ Oil-Rubbed*, Bright Brass, Polished Nickel and Satin Nickel chains and pulleys
- ▶ Half or full screens with BetterVue® or UltraVue® fiberglass screen mesh, or aluminum mesh, and aluminum frames that match unit's exterior color
- ▶ Galvanized steel installation clips
- ▶ High performance modifications



Brass chains and pulleys



Brass sash locks



Optional ogee lugs

NOTE: All measurements are nominal.

* The Oil-Rubbed finish is not available on curved sash lift handles.

This is a living finish, which means that it will change appearance over time with use.

BetterVue® and UltraVue® are registered trademarks of PHIFER INCORPORATED.

Customized options to address historical or architectural design elements are available. Please contact your Kolbe dealer.



Photo © Dan Mullins

Click to view more: kolbewindows.com/gallery

Specialty Windows

Heritage Series specialty windows are available in a variety of sizes, shapes and styles. Add radius or geometric windows to create a focal point, extend the daylight or replicate architectural details. Half-circle or elliptical units stacked above other Kolbe windows and doors create gracious curves and allow more light to enter your room. Follow the slope of a roofline or comprise a window wall with a variety of angled shapes, from triangles and trapezoids to pentagons, diamonds, or any shape you can imagine. Integrate pass-through capabilities with expansive folding windows and screens.

Folding Windows | Radius Windows | Geometric Windows

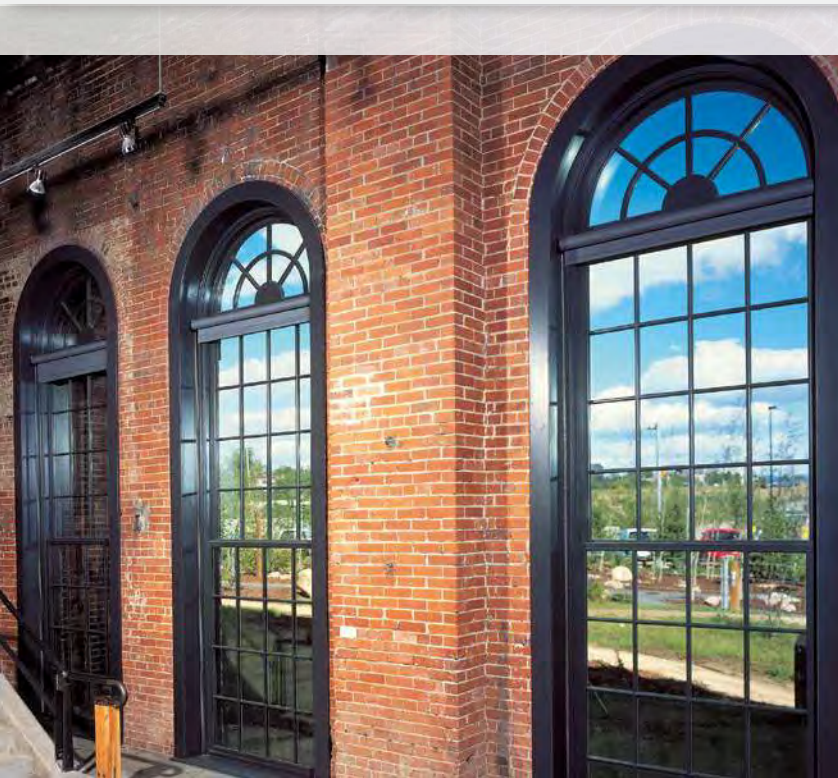

Folding Windows

Folding windows can infuse a room with a remarkable amount of fresh air by offering openings up to 52 feet wide. With up to 8 panels per side, folding windows are highly customizable with numerous configurations available. These made-to-order windows open up spaces dramatically by extending the living area to the outdoors, and allowing pass-through convenience.



Standard Features – Folding Windows

- ▶ 1-3/4" thick sash
- ▶ 6-9/16" minimum jamb width
- ▶ Folding windows feature LVL locking stiles; stiles and rails are a nominal 3" wide
- ▶ Frame setup up to 177" wide x 77-1/8" tall; all others knocked down
- ▶ Constructed of pine with pine interior stops
- ▶ 1-15/16" exterior brickmould applied
- ▶ Exterior wood parts are treated
- ▶ Exterior frame is latex primed
- ▶ Energy efficient, insulating Solar Low-E glass
- ▶ Glazed to the interior with beveled wood glazing beads
- ▶ Bronze Anodized weep sill
- ▶ Grooved guide rollers with adjustable, ball-bearing wheels carry the folding panels
- ▶ Multi-point* mortise latch with handle set in a Bright Brass finish
- ▶ Thick oak interior threshold

Options – Folding Windows (custom options are also available)

- ▶ K-Kron II exterior paint finish
- ▶ 2-1/4" thick panel
- ▶ Interior casing
- ▶ Exterior brickmould and casing (pg. 8)
- ▶ Single-point hardware for access panel
- ▶ Concealed shootbolt locking hardware for folding panels
- ▶ Stile and top rail options: 4-5/8" or 6"
- ▶ Bottom rail options: 4-5/8", 6", 7-9/16" or 12-5/8"
- ▶ 2-1/4" thick panel
- ▶ Extension jambs in a wide variety of sizes (shipped loose for field application if over 12")
- ▶ Face-mounted flush bolt locking hardware on folding panels
- ▶ Uno or Aria handle set for folding panels with concealed shootbolt locking hardware
- ▶ Hinges with handles in Bright Brass, Chrome, Satin Nickel and Matte Black
- ▶ Finger pulls for panels without hinge handles
- ▶ Magnetic latches or panel stays to help keep windows stationary while open
- ▶ Black pleated retractable insect screens; black pleated sliding screens on units with the frame setup
- ▶ Recessed floor track sill (interior), weep or non-weep in Bronze Anodized finish
- ▶ Clear Anodized weep sill
- ▶ Galvanized steel installation clips

NOTE: All measurements are nominal.

Minimum panel height is 36", minimum panel width is 16", maximum panel height is 72" and maximum panel width is 39-3/8".

* Minimum panel height for multi-point hardware is 36".

Radius Windows

Kolbe makes radius windows in stand-alone full circles, half-circles, quarter-circles, ellipticals, ovals and custom shapes. Half-circle or elliptical windows can be stacked over other Kolbe windows and doors to create larger window walls. We build our radius windows to order so that their profiles match those of the windows they complement.



© Kenneth M. Wyner



© James R. Salomon Photography

Standard Features – Radius Windows

- ▶ 1-3/4" thick sash
- ▶ Overall jamb width is 4-9/16"
- ▶ 3" straight legs on half-circles
- ▶ Constructed of pine, with pine interior stops and wood mull casings on mull units
- ▶ 1-15/16" exterior brickmould applied
- ▶ Exterior wood parts are treated
- ▶ Exterior frame and sash are latex primed
- ▶ Energy efficient, insulating Solar Low-E glass
- ▶ Glazing is sash set to the interior with beveled wood glazing beads

Options – Radius Windows (custom options are also available)

- ▶ K-Kron II exterior paint finish
- ▶ Custom shapes such as bell-tops and gothic-tops
- ▶ Interior casing
- ▶ Exterior brickmould and casing (pg. 8)
- ▶ Glazing may be direct set
- ▶ Extended legs or no legs on half-circles
- ▶ Extension jambs (up to 12" applied; over 12" shipped loose for field application)
- ▶ Galvanized steel installation clips
- ▶ High performance modifications

Radius Divided Lite Patterns Dimension calculation formulas for radius units vary per unit and application. Please contact your Kolbe dealer for formulas.

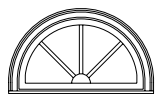

Sunburst



Open Hub Sunburst



Elliptical Sunburst

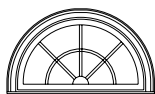

Double Cut Sunburst

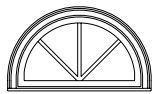

Starburst

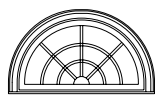

Triple Cut Sunburst



Spider Web

NOTE: 2-1/4" PDL bars are not available for patterns with curved bars. Some designs may have a composite material for the exterior PDL bar.

Geometric Windows

Make your design truly distinctive with Kolbe's geometric windows. These angled attention-grabbers create an impactful focal point and accentuate the architectural design. Kolbe can produce various window shapes and sizes, with a vast array of glazing options to create a light-filled room with a uniquely framed view..



Standard Features – Geometric Windows

- ▶ 1-3/4" thick sash
- ▶ Overall jamb width is 4-9/16"
- ▶ Constructed of pine, with pine interior stops and wood mull casings on mullied units
- ▶ 1-15/16" exterior brickmould applied
- ▶ Exterior wood parts are treated
- ▶ Exterior frame and sash are latex primed
- ▶ Energy efficient, insulating Solar Low-E glass
- ▶ Glazing is sash set to the interior with beveled wood glazing beads
- ▶ Standard geometric shapes include triangles, octagons, hexagons, pentagons, trapezoids, and diamonds

Options – Geometric Windows *(custom options are also available)*

- ▶ K-Kron II exterior paint finish
- ▶ Custom shapes
- ▶ Interior casing
- ▶ Exterior brickmould and casing *(pg. 8)*
- ▶ Glazing may be direct set
- ▶ Extension jambs *(up to 12" applied, over 12" shipped loose for field application)*
- ▶ Galvanized steel installation clips
- ▶ High performance modifications



Doors: Entrance to Expansive

Whether it's a stunning entryway or a passageway to an outdoor living area, Heritage Series doors bring beauty and elegance to any project. Customize an entry to exemplify your personal aesthetic or enhance your swinging doors with matching transoms, sidelites or radius units. Take indoor-outdoor living to various levels with sliding or folding doors, utilizing Kolbe's custom solutions and nearly endless options for glass, divided lites, hardware, finishes, and more.

*Sliding Doors | Folding Doors | Inswing Doors | Outswing Doors | Raised Panel Doors
French Doors | Sidelites & Transoms | Commercial Doors*

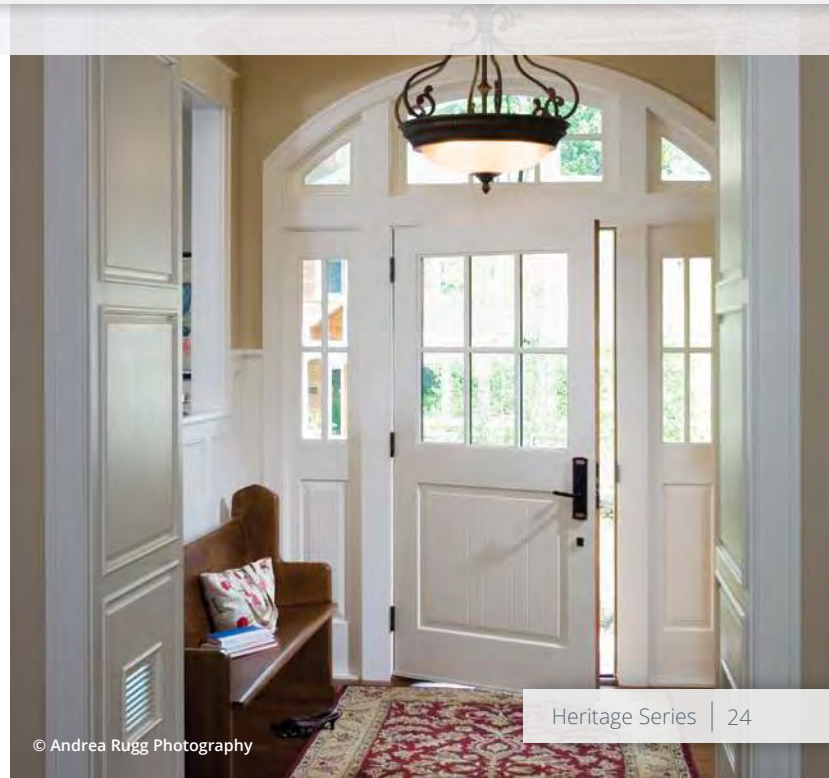
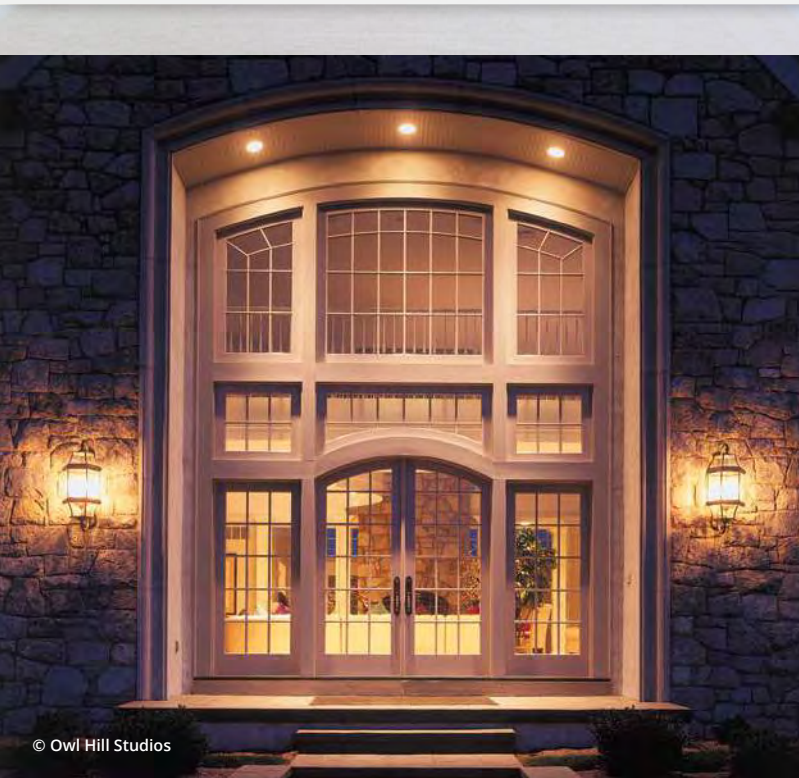

Sliding Doors

Sliding doors are a space-saving way to connect your indoor and outdoor living spaces. Slide them from side-to-side to operate in two-, three- or four-wide configurations to create easy access to the outdoors. Sliding doors are available in various sizes to accommodate new construction or remodeling projects.



Standard Features – Sliding Doors

- ▶ 1-3/4" thick sash
- ▶ Standard jamb width is 5"
- ▶ 3" wide LVL stiles and rails
- ▶ Frame setup
- ▶ Constructed of pine, with pine interior stops and wood mull casings on mull units
- ▶ Energy efficient, insulating Solar Low-E glass
- ▶ Glazed to the interior with beveled wood glazing beads
- ▶ All wood interior for clean look
- ▶ 1-15/16" exterior brickmould applied
- ▶ Exterior wood parts are treated
- ▶ Exterior frame and panels are latex primed
- ▶ Tandem rollers with adjustable, ball-bearing wheels carry the sliding panel
- ▶ Single-point mortise latch with handle set in a Bright Brass finish
- ▶ Screens with BetterVue® fiberglass mesh and extruded aluminum frames
- ▶ One-piece, pultruded fiberglass sill with continuous aluminum sill nosing and fiberglass sill filler
- ▶ Thick oak interior threshold

Options – Sliding Doors (custom options are also available)

- ▶ K-Kron II exterior paint finish
- ▶ Available with wide stiles and rails (stiles and top rail are a nominal 4-5/8", bottom rail is 7-9/16" or 12 5/8")
- ▶ 2-1/4" thick panels
- ▶ Interior casing
- ▶ Exterior brickmould and casing (pg. 8)
- ▶ Two types of escutcheon styles: bell and arch (multi-point only)
- ▶ Multi-point lock
- ▶ Keyed lock
- ▶ Secondary security lock
- ▶ Corrosion-resistant hardware
- ▶ Automated operation
- ▶ Sliding screen with fiberglass mesh and extruded aluminum screen frames
- ▶ Screens with UltraVue® fiberglass mesh or aluminum mesh
- ▶ Extension jambs in a wide variety of sizes (shipped loose for field application)
- ▶ Galvanized steel installation clips
- ▶ High performance modifications

Operational Options

3-Wide Unit

- ▶ Operation = Active-Fixed-Active (AFA)

4-Wide Unit

- ▶ Operation = Fixed-Active-Active-Fixed (FAAF)

NOTE: All measurements are nominal.
BetterVue® and UltraVue® are registered trademarks of PHIFER INCORPORATED.

Folding Doors

Breathe in fresh air, add architectural interest, and merge outdoor and indoor spaces with folding doors that swing out, fold to one side, or split and fold to either side. With up to 8 panels per side, folding doors allow massive views up to 45 feet wide – plus 90° custom corner configurations. Enjoy indoor-outdoor living with these expansive openings.



Copyright © Marco Zecchin/Image Center



© Kenneth M. Wyner Photography, Inc.

Standard Features – Folding Doors

- ▶ 1-3/4" thick sash
- ▶ 6-9/16" minimum jamb width
- ▶ Folding doors feature LVL locking stiles; stiles and top rails are a nominal 4-5/8" wide; bottom rail is a nominal 7-9/16" high
- ▶ Frame setup up to 177" wide x 106" tall; all others knocked down
- ▶ Constructed of pine with pine interior stops
- ▶ 1-15/16" exterior brickmould applied
- ▶ Exterior wood parts are treated
- ▶ Exterior frame is latex primed
- ▶ Energy efficient, insulating Solar Low-E glass (*tempered glass is standard on folding doors*)
- ▶ Glazed to the interior with beveled wood glazing beads
- ▶ Bronze Anodized weep sill
- ▶ Grooved guide rollers with adjustable, ball-bearing wheels carry the folding panels
- ▶ Multi-point mortise latch with handle set in a Bright Brass finish
- ▶ Face-mounted flush bolt locking hardware on folding panels
- ▶ Thick oak interior threshold

Options – Folding Doors *(custom options are also available)*

- ▶ K-Kron II exterior paint finish
- ▶ Bottom rail options: 4-5/8", 6" or 12-5/8"
- ▶ 2-1/4" thick panel
- ▶ Extension jambs in a wide variety of sizes (*shipped loose for field application if over 12"*)
- ▶ Interior casing
- ▶ Exterior brickmould and casing (*pg. 8*)
- ▶ Concealed shootbolt locking hardware for folding panels
- ▶ Single-point hardware for access door
- ▶ Black pleated sliding screens available up to 177" wide x 102" tall (*screen opening size; screen only available on units with the frame setup*)
- ▶ Recessed floor track sill (*interior*), weep or non-weep in Bronze Anodized finish
- ▶ Clear Anodized weep sill
- ▶ Galvanized steel installation clips

NOTE: All measurements are nominal.
Limitations may apply. See your Kolbe dealer for product specifics.

Inswing Doors

Whether it's an entrance door or a sliding door, Kolbe offers custom options to personalize any entryway. Choose from various glass, panel configurations, wood species and finishes to make a personal statement. Add further distinction to a single, double or French unit with sidelites or transoms.



Standard Features – Inswing Doors

- ▶ 1-3/4" thick sash panel prehung in the 1-5/16" frame; entrance doors are prehung in the 3/4" frame with a 9/16" stop
- ▶ Standard jamb width is 4-9/16"
- ▶ LVL locking stiles; stiles and top rails are a nominal 4-5/8" wide; bottom rail is a nominal 7-9/16" high
- ▶ Constructed of pine, with pine interior stops and wood mull casings on mull units
- ▶ Joints between stiles and rails are fastened with splined hardwood dowels
- ▶ Energy efficient, insulating Solar Low-E glass
- ▶ Glazed to the interior with beveled wood glazing beads
- ▶ 1-15/16" exterior brickmould applied
- ▶ Exterior wood parts are treated
- ▶ Exterior frame is latex primed
- ▶ Hoppe® European style Toronto handle set in a Bright Brass finish
- ▶ HLS 9000 stainless steel multi-point locking hardware on single door panels; French doors have a 3-point lock on the active panel and a 2-point lock on the less active panel
- ▶ Adjustable, 4" x 3-5/8" hinges with 5/8" radius corners in a Gold-painted finish
- ▶ Sliding screen with BetterVue® fiberglass mesh and extruded aluminum frames
- ▶ Bronze Anodized aluminum, self-draining exterior sill with an oak interior threshold

Options – Inswing Doors (custom options are also available)

- ▶ K-Kron II exterior paint finish
- ▶ 2-1/4" thick door panels
- ▶ Extension jambs in a variety of sizes
- ▶ 3" or 6" optional stiles and optional 12-5/8" bottom rail
- ▶ Interior casing
- ▶ Exterior brickmould and casing (pg. 8)
- ▶ 2-point flush bolt lock on less active panel of French doors
- ▶ Single-point locking system
- ▶ Electronic multi-point lock (available for select single-panel doors up to 8' high with stiles wider than 3"; not available on double or French door configurations. Not recommended for coastal applications.)
- ▶ Adjustable, 4" x 3-5/8" hinges with 5/8" radius corners in additional finishes
- ▶ Non-adjustable, residential 4" x 4" ball-bearing hinges with 1/4" radius corners in a variety of finishes
- ▶ Non-adjustable, commercial-grade 4" x 4" ball-bearing hinges with square corners, and 4-1/2" x 4-1/2" hinges in select finishes
- ▶ Self-closing, swinging screen includes a spring-loaded lock, aluminum screen frame to match unit exterior and choice of BetterVue® or UltraVue® fiberglass mesh or aluminum mesh
- ▶ Clear Anodized weep sill
- ▶ Adjustable sills in Bronze or Clear Anodized
- ▶ Oak or Mahogany sills
- ▶ Thermal break or non-thermal break ADA-compliant sills
- ▶ Galvanized steel installation clips

NOTE: All measurements are nominal.

All-wood sills are not recommended for use in high moisture conditions.

BetterVue® and UltraVue® are registered trademarks of PHIFER INCORPORATED.

Outswing Doors

Outswing doors are available with the same multitude of options as inswing doors, but swing outward for areas that have space constraints. Outswing entrance doors are available in single, double and French units, and can be customized with sidelites or transoms to create a distinctive opening.



Standard Features – Outswing Doors

- ▶ 1-3/4" thick sash panel, prehung in the 1-1/16" frame with a 1/2" rabbeted-in stop
- ▶ Standard jamb width is 4-9/16"
- ▶ LVL locking stiles; stiles and top rails are a nominal 4-5/8" wide; bottom rail is a nominal 7-9/16" high on all doors
- ▶ Constructed of pine, with pine interior stops and wood mull casings on mullied units
- ▶ Joints between stiles and rails are fastened with splined hardwood dowels
- ▶ Energy efficient, insulating Solar Low-E glass
- ▶ Glazed to the interior with beveled wood glazing beads
- ▶ 1-15/16" exterior brickmould applied
- ▶ Exterior wood parts are treated
- ▶ Exterior frame is latex primed
- ▶ Hoppe® European style Toronto handle set in a Bright Brass finish
- ▶ Non-adjustable, residential 4" x 4" ball-bearing hinges with 1/4" radius corners in a Bright Brass finish
- ▶ Bronze Anodized aluminum bumper sill with oak interior threshold

Options – Outswing Doors *(custom options are also available)*

- ▶ K-Kron II exterior paint finish
- ▶ 2-1/4" thick door panels
- ▶ Extension jambs *(up to 12" applied; over 12" shipped loose for field application)*
- ▶ 3" or 6" optional stiles and optional 12-5/8" bottom rail
- ▶ High profile panel moulding
- ▶ Interior casing
- ▶ Exterior brickmould and casing *(pg. 8)*
- ▶ Electronic multi-point lock *(available for select single-panel doors up to 8' high with stiles wider than 3"; not available on double or French door configurations. Not recommended for coastal applications.)*
- ▶ HLS 9000 stainless steel multi-point locking hardware on single panel doors; French doors have a 3-point lock on the active panel and a 2-point lock on the less active panel
- ▶ 2-point flush bolt lock on less active panel of French doors
- ▶ Single-point locking system
- ▶ Adjustable, 4" x 3-5/8" hinges with 5/8" radius corners in a variety of finishes
- ▶ Non-adjustable, residential 4" x 4" ball-bearing hinges with 1/4" radius corners in additional finishes
- ▶ Non-adjustable, commercial-grade 4" x 4" ball-bearing hinges with square corners, and 4-1/2" x 4-1/2" hinges in select finishes
- ▶ Clear Anodized bumper sill
- ▶ Oak or Mahogany sill
- ▶ Thermal break or non-thermal break ADA-compliant sill
- ▶ Galvanized steel installation clips
- ▶ High performance modifications

NOTE: All measurements are nominal.
All-wood sills are not recommended for use in high moisture conditions.

Professional Tools

Kolbe prides itself on offering the tools and resources architects, builders and other industry professionals need to complete their projects. From product specifications and 3D models to continuing education courses and webinars, Kolbe supports all of your project needs.



AIA/CES Courses

As a Registered AIA Continuing Education Services (CES) provider, Kolbe provides AIA Learning Units (LU) and/or Health, Safety & Welfare (HSW) credits as required per state and/or professional memberships to meet yearly requirements.

Virtual Showrooms

Experience Kolbe's full capabilities through two interactive showrooms filled with product displays and custom solutions.

Showroom Tour

Browse through 26 displays to see Kolbe's innovative products and options in unique configurations.

Exhibit Tour

brand new booth from IBS 2023, filled with trendy solutions for modern living.



Architect Library

Kolbe's Architect Library is the main resource for specifying Ultra Series windows and doors. Search detailed product information and technical data, including:

- Cross section drawings
- Elevation charts
- 3D Revit® models
- CSI specifications
- Installation instructions

Additional resources include:

- Door configurations
- Clear openings
- Care & maintenance guide
- Acoustic data
- Energy performance
- Performance class & grade
- Product brochures
- Color & design samples
- Warranties

Inspiration Gallery

Browse through photos, videos, project profiles and custom solutions.

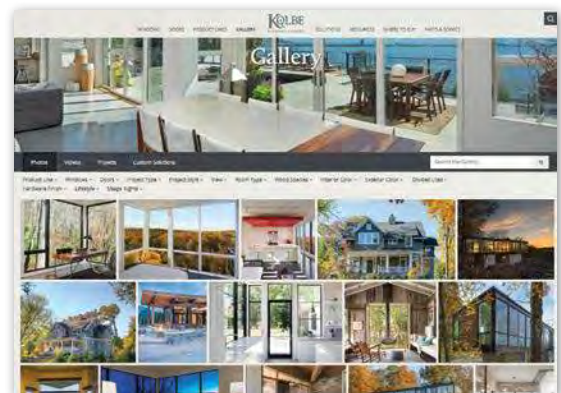



KOLBE

WINDOWS & DOORS
We're for the visionaries.®

1323 S. 11th Avenue | Wausau, WI 54401-5998
715.842.5666

www.kolbewindows.com

© 2024 Kolbe & Kolbe Millwork Co., Inc. Kolbe & Kolbe Millwork Co., Inc. reserves the right to change specifications without notice. The photography featured herein does not necessarily imply an endorsement of Kolbe products by the property owners. Photography used may not represent current Kolbe product features and options. Front cover photo: Moore Architects, LEED® Silver | © Hoachlander Davis Photography



Street view of entry gate on Camino del Monte Sol



Street view on Camino del Monte Sol (house uphill on left)



Street view of house on Camino del Monte Sol



Street view of house on Camino del Monte Sol



Street view of house on Camino del Monte Sol



Street view of house on Camino del Monte Sol



Street view of house on Camino del Monte Sol



Street view of house on Camino del Monte Sol
("service" gate at rear of house)



Entry View (north elevation) of house on Camino del Monte Sol



North Elevation



North Elevation



North Elevation



North Elevation



North Elevation



North Elevation



North Elevation



North Elevation



East Elevation



East Elevation



East Elevation



East Elevation



East Elevation



East Elevation



South Elevation



South Elevation



South Elevation
(rear courtyard wall)



South Elevation
(rear courtyard wall)



South Elevation
(rear courtyard)



South Elevation
(rear courtyard wall)



South Elevation
(rear courtyard wall)



South Elevation
(rear courtyard)



South Elevation (rear courtyard gate)



South Elevation
(rear courtyard gate and wall,
condenser fence screening in
foreground)



South Elevation (condenser screening in foreground, service gate to left)



West Elevation



West Elevation