

A R C H I T E C T U R E
M A R T I N E Z
S T U D I O P C

TEL (505) 989-4958 MAIL: P O BOX 925 SANTA FE NM 87504
1524 PASEO DE PERALTA — STUDIO@MARTINEZARCH.COM

STATUS REVIEW

433 Calle La Paz

July 14, 2025

Downtown/Eastside Historic District, Contributing status

EXISTING CONDITIONS:

On behalf of the property owners, John Gregory and Pamela Austin, the attached application requests a status review and primary elevation designation of the above-referenced property.

Sincerely,

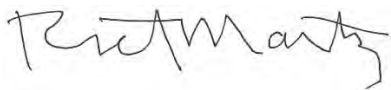

Richard Martinez
Martinez Architecture Studio PC

Historic Cultural Properties Inventory (HCPI) Base Form (FORM 1)

Historic Preservation Division, New Mexico Department of Cultural Affairs

Date of Form: July 12, 2025

For HPD Office use only:		
HCPI No. _____	District No. _____	NRHP <input type="checkbox"/> SRCP <input type="checkbox"/> Criteria <u> </u> A <u> </u> B <u> </u> C <u> </u> D <u> </u>
1. Name of property: Frank and Alma Hudson House/ Robert and Mary Neidorf Residence	2. Location: 433 Camino la Paz Downtown and Eastside Historic District – Santa Fe	3. Local Reference Number: Santa Fe ID: H-641 4. County: Santa Fe Parcel # 10322816
5. Property Type: <input checked="" type="checkbox"/> Buildings: 3 <input checked="" type="checkbox"/> Structures: walls and fences <input type="checkbox"/> Site <input type="checkbox"/> Object		
6. Date of Survey: May 28, 2025, JWM		
7. Previous Survey Date(s): <input checked="" type="checkbox"/> Yes: July 6, 1983, Michael Belshaw, September 1991, Deborah Butcher <input type="checkbox"/> No:		
8. Name of Project: HDRB Status Evaluation		
9. Lat/Long: 35.6791818,-105.9319022		
10. Photo Information; John W. Murphey, photographer. Photo 1: View of west elevation on Calle la Paz. Camera facing east.		
11. Brief Description of the Property: <p>Erected between 1912 and 1930, the original core of the primary residence consists of a 17-by-36-foot adobe rectangle, to which at least four additions have been appended. These include a façade addition that postdates 1966. The property also contains an older one-bay garage at the northwest corner and a guesthouse along Camino Manzano which was constructed in the early 1980s. The property is enclosed by non-historic walls and fences. The primary house is classified as Contributing to the Downtown and Eastside Historic District; the garage, guesthouse, and walls have no status.</p> <p><i>Continued on Page 5.</i></p>		
12. Who uses the property? Dwelling		
13. Construction Date: Date: Primary House, before 1930, with multiple additions after; Guesthouse, early 1980s; Garage, pre-1958 <input checked="" type="checkbox"/> Known <input checked="" type="checkbox"/> Estimated Source: plat maps and aerial photographs		
14. Setting: <input checked="" type="checkbox"/> Suburban <input type="checkbox"/> Rural <input type="checkbox"/> Village <input type="checkbox"/> Urban If Urban: <input type="checkbox"/> Commercial <input type="checkbox"/> Industrial <input checked="" type="checkbox"/> Residential <input type="checkbox"/> Public		

15. Relationship to Surroundings: Similar Dissimilar

Comments: N/A

16. Additional Perspective: (Photos, drawing, footprint, etc., indicate north arrow when possible)



Source: Office of the Santa Fe County Assessor
Blue parcel lines are not accurate



17. Surveyor:
(your name, address, telephone number, and any group affiliation)

John W. Murphey
Architectural Historian
Architectural History Services
505-577-7593/707-583-7819
John@archhistoryservices.com

For: Current owner and Richard Martinez, AIA,
NOMA NM

18. Owner (if known) and other knowledgeable people:

Current owner: John C. Gregory Revocable Trust & Pamela S. Austin Revocable Trust
N/A

19. Is Property Endangered? Unknown No Yes How?

20. Significance to Current Community: Unknown None Low Moderate High
Describe: Unknown

21. Other Significance or Information of Interest: (such as historical, legendary, structural, former ownership, etc.)
See Historical Overview.

22. National or State Register:

Is this property individually listed on a historic register? Unknown No Yes
If yes: State National

If 'no' or unknown, do you think this property is eligible for listing? No Yes
Why? See Evaluation of Historical Status

23. National or State Historic District: City of Santa Fe

Is this property in a historic district? Unknown No Yes
If yes: Significant Contributing: Primary House Non-contributing No Status: Guesthouse, Garage, and Walls and Fences
Per City of Santa Fe official designation map

If 'yes', what is the name of the district? State National City of Santa Fe:
Downtown and Eastside Historic District

24. Supplemental Forms:

None HCPI Detail Form (FORM 2) Continuation Sheets, # pages: _____

Historic Cultural Properties Inventory (HCPI) Detail Form (FORM 2)

Historic Preservation Division, New Mexico Department of Cultural Affairs

For HPD Office use only: HCPI No. _____ District No. _____		Please complete HCPI FORM 1 before completing FORM 2 NRHP _____ SRCP _____ Criteria <u> </u> A <u> </u> B <u> </u> C <u> </u> D																																																																													
1. Name of property: Frank and Alma Hudson House/ Robert and Mary Neidorf Residence	2. Location: 433 Camino la Paz Downtown and Eastside Historic District – Santa Fe	3. Local Reference Number: Santa Fe ID: H-641																																																																													
		4. County: Santa Fe																																																																													
		5. Date of Survey: May 28, 2025																																																																													
ARCHITECTURAL AND CONSTRUCTION DETAILS:																																																																															
6. Visible Construction Material: <u> </u> All Buildings		7. Number of Stories: <u> </u> N/A Number: <u> </u> x_1 <u> </u> 11/2 <u> </u> 2 <u> </u> 21/2 Other: _____																																																																													
<input type="checkbox"/> _x_Adobe <input type="checkbox"/> Brick <input type="checkbox"/> Composition <input type="checkbox"/> Concrete: Block <input type="checkbox"/> Concrete: Cast Stone <input type="checkbox"/> Concrete: Poured <input type="checkbox"/> Earth Plaster <input type="checkbox"/> Masonry: Simulated <input type="checkbox"/> Metal: Corrugated <input type="checkbox"/> Metal: Structural Siding <input type="checkbox"/> Metal: V-Crimp <input type="checkbox"/> Stone: Random Ashlar <input type="checkbox"/> Stone: Random Coursed <input type="checkbox"/> Stone: River Rock <input type="checkbox"/> Stone: Rusticated <input type="checkbox"/> Stone: Tabular <input type="checkbox"/> _x_Stucco: <input type="checkbox"/> Tile: Clay <input type="checkbox"/> Vinyl Siding <input type="checkbox"/> Wood: Board and Batten <input type="checkbox"/> Wood: Horizontal Siding <input type="checkbox"/> Wood: Jacal <input type="checkbox"/> Wood: Log <input type="checkbox"/> Wood: Shingle <input type="checkbox"/> Wood: Tongue and Groove <input type="checkbox"/> Other:		8. Foundation: <u> </u> N/A <input type="checkbox"/> _x_ Not visible <input type="checkbox"/> None <input type="checkbox"/> At Grade <input type="checkbox"/> Raised: Materials: <input checked="" type="checkbox"/> _x_ Concrete: <input type="checkbox"/> _ Stone Other: Notes																																																																													
		9. Roof: <u> </u> N/A Shape: <input checked="" type="checkbox"/> _x_Flat <input type="checkbox"/> Gabled <input type="checkbox"/> Hipped <input type="checkbox"/> Pyramidal <input checked="" type="checkbox"/> _x Shed Other: Pitch: <input type="checkbox"/> None <input type="checkbox"/> Low <input type="checkbox"/> Medium <input type="checkbox"/> Steep Features: <input type="checkbox"/> Eave: <input checked="" type="checkbox"/> _x Parapets Materials: <input checked="" type="checkbox"/> _x Asphalt <input type="checkbox"/> Earth <input type="checkbox"/> Composition shingle <input type="checkbox"/> Metal: Pressed <input type="checkbox"/> Composition Roll <input type="checkbox"/> Metal: Corrugated <input type="checkbox"/> Metal: Standing Seam <input type="checkbox"/> Metal: Standing Seam <input type="checkbox"/> Tile: Terra Cotta <input type="checkbox"/> Wood: Shingle <input type="checkbox"/> Other:																																																																													
10. Window Types		11. Door Types																																																																													
<table border="1" style="width: 100%; border-collapse: collapse; text-align: center;"> <thead> <tr> <th>Operation</th> <th>Material</th> <th>Glazing</th> <th>Number</th> </tr> </thead> <tbody> <tr><td>Single-Hung</td><td>Wood</td><td>1/1</td><td>1</td></tr> <tr><td>Single-Hung</td><td>Vinyl</td><td>1/1</td><td>1</td></tr> <tr><td>Single-Hung</td><td>Wood</td><td>2/1</td><td>3</td></tr> <tr><td>Single-Hung</td><td>Wood</td><td>2/2</td><td>2</td></tr> <tr><td>Single-Hung</td><td>Clad Wood</td><td>6/1</td><td>1</td></tr> <tr><td>Sash-Fixed Position</td><td>Wood</td><td>6</td><td>2</td></tr> <tr><td>Sash-Fixed Position</td><td>Wood</td><td>8</td><td>2</td></tr> <tr><td>Awning</td><td>Wood</td><td>1</td><td>1</td></tr> <tr><td>Casement</td><td>Wood</td><td>4</td><td>1</td></tr> <tr><td>Casement</td><td>Wood</td><td>4</td><td>1</td></tr> <tr><td>Sliding</td><td>Wood</td><td>1-1</td><td>2</td></tr> <tr><td>Clerestory</td><td>Wood</td><td>H-F-F-H</td><td>1</td></tr> </tbody> </table>		Operation	Material	Glazing	Number	Single-Hung	Wood	1/1	1	Single-Hung	Vinyl	1/1	1	Single-Hung	Wood	2/1	3	Single-Hung	Wood	2/2	2	Single-Hung	Clad Wood	6/1	1	Sash-Fixed Position	Wood	6	2	Sash-Fixed Position	Wood	8	2	Awning	Wood	1	1	Casement	Wood	4	1	Casement	Wood	4	1	Sliding	Wood	1-1	2	Clerestory	Wood	H-F-F-H	1	<table border="1" style="width: 100%; border-collapse: collapse; text-align: center;"> <thead> <tr> <th>Type</th> <th>Style</th> <th>Material</th> <th>Number</th> </tr> </thead> <tbody> <tr><td>Single-Leaf</td><td>Plank</td><td>Wood</td><td>1</td></tr> <tr><td>Single-Leaf</td><td>Panel</td><td>Wood</td><td>1</td></tr> <tr><td>Single-Leaf</td><td>Panel</td><td>Metal</td><td>1</td></tr> <tr><td>Double</td><td>French</td><td>Wood</td><td>2</td></tr> <tr><td>Overhead</td><td>Garage</td><td>Wood</td><td>1</td></tr> </tbody> </table>		Type	Style	Material	Number	Single-Leaf	Plank	Wood	1	Single-Leaf	Panel	Wood	1	Single-Leaf	Panel	Metal	1	Double	French	Wood	2	Overhead	Garage	Wood	1
Operation	Material	Glazing	Number																																																																												
Single-Hung	Wood	1/1	1																																																																												
Single-Hung	Vinyl	1/1	1																																																																												
Single-Hung	Wood	2/1	3																																																																												
Single-Hung	Wood	2/2	2																																																																												
Single-Hung	Clad Wood	6/1	1																																																																												
Sash-Fixed Position	Wood	6	2																																																																												
Sash-Fixed Position	Wood	8	2																																																																												
Awning	Wood	1	1																																																																												
Casement	Wood	4	1																																																																												
Casement	Wood	4	1																																																																												
Sliding	Wood	1-1	2																																																																												
Clerestory	Wood	H-F-F-H	1																																																																												
Type	Style	Material	Number																																																																												
Single-Leaf	Plank	Wood	1																																																																												
Single-Leaf	Panel	Wood	1																																																																												
Single-Leaf	Panel	Metal	1																																																																												
Double	French	Wood	2																																																																												
Overhead	Garage	Wood	1																																																																												
12. Chimneys <input checked="" type="checkbox"/> _x_ N/A		13. Porches <u> </u> N/A Type: <input checked="" type="checkbox"/> _x_ Entry <input type="checkbox"/> _x_Partial-Width <input type="checkbox"/> Full-Width <input type="checkbox"/> Wrap																																																																													
14. Other Significant Features N/A																																																																															

15. Modifications: ___ No known modifications

#1 Date: Various; multiple additions to the primary house; most within the historic period; maps, aerial photographs, and visual evidence

#2 Date: Early 1980s; construction of guesthouse, potentially including an older structure; 1983 HBI form

#3 Date: Post-1978 (1983); alteration of existing and introduction of new walls and fences; aerial photographs and 1983 HBI form

#4 Date: c.2001; raising ceiling and roof of east side of primary house and adding brick coping; Case H-01-126

#5 Date: c.2001 replacement of a door and several windows of the primary house; Case H-01-126, visual evidence

16. Primary Architectural Style Not Applicable

Art Deco/Streamline Moderne Gothic Revival Mission Revival Pueblo Spanish-Pueblo Revival
 Bungalow/Craftsman International Neo-Classical Queen Anne Territorial
 Colonial Revival Italianate Northern NM Ranch Territorial Revival
 Folk Victorian Mediterranean Prairie Spanish-Colonial Tudor Revival

Notes: Other: Vernacular; Passive Solar

17. Documents Available and Their Locations

Historic Preservation Division
Land Use Department
City of Santa Fe
200 Lincoln Avenue
Santa Fe, NM 87504
(505) 955-6605
<https://www.santafenm.gov/land-use/historic-preservation>

Archaeological Records Management Section
Laboratory of Anthropology
708 Camino Lejo
Santa Fe, NM 87501
(505) 476-1320
<https://nmhistoricpreservation.org/arms.html>

SITE:

18. Attached or Associated Properties

Are associated properties eligible for listing: N/A

19. Site Plan: Portion of 2000 survey boundary map. Courtesy of Sierra Land Surveying, Inc.

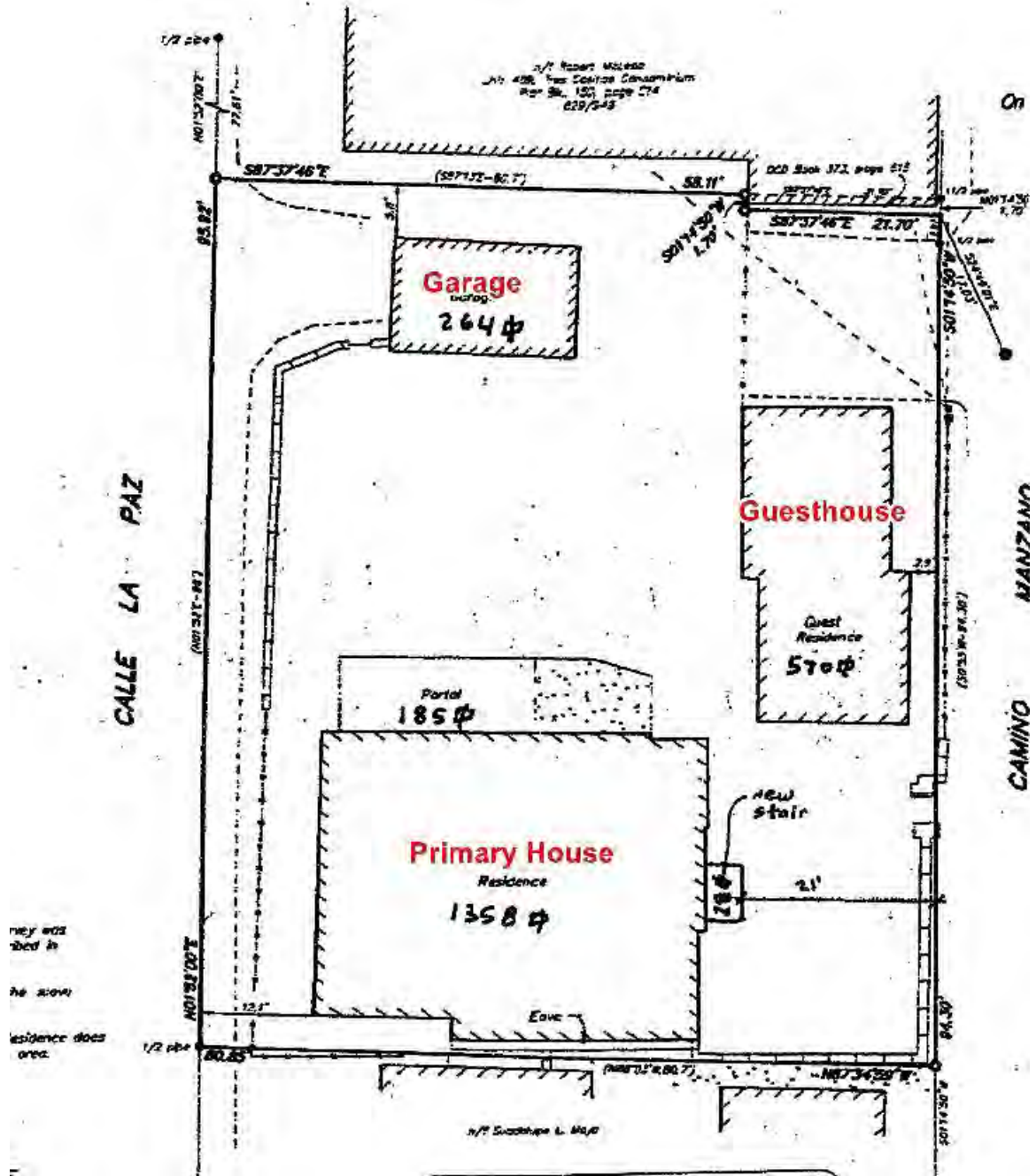

Historic Cultural Properties Inventory (HCPI) Detail Form (FORM 2)

Historic Preservation Division, New Mexico Department of Cultural Affairs

For HPD Office use only:		<i>Please complete HCPI FORM 1 before completing FORM 2</i>			
HCPI No. _____	District No. _____	NRHP _____	SRCP _____	Criteria <u> </u> A <u> </u> B <u> </u> C <u> </u> D	
1. Name of property: Frank and Alma Hudson House/ Robert and Mary Neidorf Residence	2. Location: 433 Camino la Paz Downtown and Eastside Historic District – Santa Fe	3. Local Reference Number: Santa Fe ID: H-641			
		4. County: Santa Fe			
		5. Date of Survey: May 28, 2025			

Architectural Description Continued

Setting

The house and its ancillary structures occupy a roughly 0.16-acre rectangular lot on the east side of Calle la Paz, a short dirt lane constructed across a former apple orchard. Except for the garage, the property is mostly concealed by non-historic walls and fences erected after 1983 (Photos 1 & 34). Within the enclosure, the three buildings form a courtyard surfaced with gravel and brick walkways. Vegetation is limited to a few older trees, including an apricot tree and a recently planted bed of lavender.

Primary House

Dating to the early 20th century, the primary house remains mostly legible across its front façade, while its other elevations have been altered by additions largely completed by the 1970s (Photo 3)(Fig. 5). The house reflects a later vernacular interpretation of the Territorial style, with the closet addition exhibiting Pueblo Revival influences. The older sections are trimmed with a full cornice composed of a header, rowlock, and stretcher brick pattern running from top to bottom. The coping on the additions repeats the original brick pattern but lacks the dentil detailing at the rowlock course and uses a different color of brick. The brick cornice on the east façade was installed in 2001, following an increase in roof height by approximately one foot over the kitchen and bathroom areas.

The house and its additions display compound massing, articulated through varied roof heights and projecting volumes. The entire building is finished with a buckskin-colored cementitious stucco coat. Important character-defining elements include the historic rectangular core, original fenestration openings fitted with two-over-one wood windows, and the brick cornice.

North (Façade)

The façade presents an overall asymmetrical composition. It is horizontally oriented, with a dominant, nearly solid mass on the left (east) side offset by an open portal on the right (west) (Photo 3). Although the original core included a centered door flanked by

Historic Cultural Properties Inventory (HCPI) Detail Form (FORM 2)
 Historic Preservation Division, New Mexico Department of Cultural Affairs

For HPD Office use only: HCPI No. _____		Please complete HCPI FORM 1 before completing FORM 2			
District No. _____	NRHP _____	SRCP _____	Criteria <u> </u> A <u> </u> B <u> </u> C <u> </u> D		
1. Name of property: Frank and Alma Hudson House/ Robert and Mary Neidorf Residence	2. Location: 433 Camino la Paz Downtown and Eastside Historic District – Santa Fe	3. Local Reference Number: Santa Fe ID: H-641			
		4. County: Santa Fe			
		5. Date of Survey: May 28, 2025			

symmetrically placed windows, the off-center portal and the 1970s closet-bathroom addition together give the façade its current asymmetrical appearance.

Portal

The portal sits approximately 24 inches above grade (Photo 4). It has recent brick flooring, and its decking is finished with unweathered tongue-and-groove boards. The structure is supported by wood posts measuring 26 inches in circumference, set on concrete pier blocks.

The front entrance consists of a 35½-by-78½-inch screwed plank door with stacked vision lights and decorative metal hinges (Photo 5). At its threshold, the front wall measures approximately 23 inches thick (Photo 6). To the right (west) is a vertical sidelight that, based on its placement and materials, is likely not original.

Windows

The windows flanking the entry illuminate the front room, originally a sala-like space that has since been subdivided. These windows are of a two-over-one wood sash design (Photo 7).

The interior muntin profile of the right (west) window has a ¼-inch face with simple bevel molding and is fitted with a surface-mounted cam-action sash lock (Photo 8). The window is set back approximately 12½ inches from the interior wall, reflecting the substantial depth of the adobe wall construction.

West

The west elevation faces Calle la Paz and contains the oldest portions of the house (Photo 10). The sala space is fenestrated by two six-light fixed sash windows with ¼-inch muntin profiles (Photo 11). The adjacent addition, which contains a bedroom, has a two-over-one hung-sash wood window with a ⅝-inch muntin face (Photo 12).

Historic Cultural Properties Inventory (HCPI) Detail Form (FORM 2)
 Historic Preservation Division, New Mexico Department of Cultural Affairs

For HPD Office use only:		<i>Please complete HCPI FORM 1 before completing FORM 2</i>			
HCPI No. _____	District No. _____	NRHP _____	SRCP _____	Criteria <u> </u> A <u> </u> B <u> </u> C <u> </u> D	
1. Name of property: Frank and Alma Hudson House/ Robert and Mary Neidorf Residence	2. Location: 433 Camino la Paz Downtown and Eastside Historic District – Santa Fe	3. Local Reference Number: Santa Fe ID: H-641			
		4. County: Santa Fe			
		5. Date of Survey: May 28, 2025			

South

Sitting close to the neighboring property, the south elevation incorporates the early bedroom and dining room additions, as well as the kitchen space which was already evident in a 1958 aerial photograph (Photo 13)(Fig. 3). Both the bedroom and dining room have modern replacement windows (Photos 14 & 15). The kitchen contains a recent two-over-two sash window.

East

The east elevation reveals a conglomeration of additions expressed through varied roof heights and parapet treatments (Photo 16). Starting at the south end are double 10-light modern doors opening into the kitchen (Photo 17). Next is a non-historic two-over-two window at the bathroom, followed by a four-light casement window at the closet (Photo 18). Both of these latter spaces were constructed after 1966 (Figs. 4 & 5).

Interior

The interior contains eight rooms, most of them resulting from additions made after the initial construction in the 1910s. The most significant space is the main front room, which appears to have originally functioned as a sala-like gathering area before being subdivided with a partition. The large section immediately behind the front entry door measures 13 feet ½ inch wide by 22 feet 4 inches long (Photo 19).

It has a slightly sloping ceiling, rising to 10 feet 10 inches at its highest point. Eight vigas span the room in a north-to-south orientation, topped with loose tongue-and-groove boards. The space is austere: features are limited to a simple baseboard finished with a strip of quarter round forming a shoe rail. The floor consists of 2 ⅝-inch-wide wood strips that have been coated with gray paint.

The partitioned section of the former sala now serves as the primary bedroom—a small, dark space with even less trim than the larger area (Photo 20). Beyond it, to the east, lies the closet and bathroom addition, which is the most recent extension grafted onto the house (Photo 21).

Historic Cultural Properties Inventory (HCPI) Detail Form (FORM 2)

Historic Preservation Division, New Mexico Department of Cultural Affairs

For HPD Office use only:		<i>Please complete HCPI FORM 1 before completing FORM 2</i>			
HCPI No.	District No.	NRHP	SRCP	Criteria <u> </u> A <u> </u> B <u> </u> C <u> </u> D	
1. Name of property: Frank and Alma Hudson House/ Robert and Mary Neidorf Residence	2. Location: 433 Camino la Paz Downtown and Eastside Historic District – Santa Fe	3. Local Reference Number: Santa Fe ID: H-641			
		4. County: Santa Fe			
		5. Date of Survey: May 28, 2025			

South of the front entry is a small dining area and an adjacent bathroom painted red, with flooring that shows signs of failure (Photo 22). The bedroom to the west, one of the earlier additions, is cramped and contains a furred-out closet (Photo 23). The kitchen to the east is completely modern in its design, finishes, and fenestration (Photo 24). Each of the older rooms has a different ceiling height, and in the case of the front and dining rooms, the vigas are arranged in different directions. The second bedroom floor is 2 inches lower than that of the adjacent dining room. These variations suggest a pattern of accretive construction.

Guesthouse

Erected in the early 1980s, the roughly 564-square-foot guesthouse is primarily of frame construction (Photo 25). It has a boxy design with a large south-facing clerestory window, reflecting an intention to mimic passive solar construction. It features a double-height volume on the north and a lower, one-story section on the south. The south piece may have incorporated an earlier structure.

The main west façade has a metal panel door flanked by wood sliding sash windows (Photo 25). The south elevation, enclosing the kitchen, includes 10-light French doors and a modern 1/1 wood sash window (Photo 26), while the upper level holds the clerestory unit.

The east elevation, fronting Camino Manzano, contains a few modern wood windows (Photo 27). The north elevation is a solid wall without openings (Photo 28). Inside, the double-height space emphasizes the passive solar design with a solid north wall and brick floor meant to retain heat gained through the clerestory window (Photo 29); however, the frame construction and large, leaky windows undermine this intention.

Garage

Standing in the northwest corner of the property is a one-bay garage, which was already present in the 1958 aerial photograph (Fig. 3). Constructed of hollow clay tile blocks and finished with stucco matching the yard walls, the garage has a gross footprint of approximately 252 square feet. It has a flat roof that has been modified with a plywood overhang. The garage faces south and is fitted with a “double-chevron” wood overhead door (Photo 30). An older decorative metal lamp is mounted at the south corner.

Historic Cultural Properties Inventory (HCPI) Detail Form (FORM 2)

Historic Preservation Division, New Mexico Department of Cultural Affairs

For HPD Office use only: HCPI No. _____ District No. _____		<i>Please complete HCPI FORM 1 before completing FORM 2</i>			
		NRHP	SRCP	Criteria A B C D	
1. Name of property: Frank and Alma Hudson House/ Robert and Mary Neidorf Residence	2. Location: 433 Camino la Paz Downtown and Eastside Historic District – Santa Fe	3. Local Reference Number: Santa Fe ID: H-641			
		4. County: Santa Fe			
		5. Date of Survey: May 28, 2025			

Pedestrian access is provided from the south through a non-original wood door, painted red (Photo 31). The east elevation contains an eight-light sash turned on its side (Photo 32), while the north elevation has no openings (Photo 33).

Walls and Fences

Based on aerial imagery and a photograph from the 1983 HBI survey, all of the walls and fences surrounding the property are of recent construction. A much lower front yard wall is visible in the 1983 survey photo (Fig. 6). This earlier wall appears to be no taller than four feet. Today, a wall in this location stands at 70 inches and incorporates an arched gate opening that reaches 90 inches at its apex (Photo 2). South of this wall begins a section of board fence, which reaches 72 inches at its highest point. Similar walls and fences are present along the east side of the property, fronting Camino Manzano (Photo 34). None of these enclosures are of historic age.

Historical Overview

Subdividing Farmland

The long, narrow tracts south of the Acequia Madre began as irrigated farmland, producing the small but essential crops that sustained Santa Fe’s early residents. In the early 20th century, some of these fields gave way to orchards—most notably apples—before eventually being carved into modest residential parcels as the city’s edge slowly pushed outward beyond its historic core.

One such story unfolds along Camino Manzano, first laid out as an apple orchard by Jacob W. Waffensmith (also recorded as Waffenschmidt), a physician who left Ohio in search of new ground and new chances. Waffensmith built his residence at 415 Camino Manzano, with its tall water tower which looks over the subject property.¹ As shown on

¹ “415 Camino Manzano, Joseph and Helen Flynn House and Associated Buildings, Santa Fe, Santa Fe County, New Mexico,” New Mexico Historic Cultural Properties Inventory 1 & 2. Prepared for Hoopes + Associates, Architects, Ltd. Co., August 29, 2017; revised September 13, 2017

Historic Cultural Properties Inventory (HCPI) Detail Form (FORM 2)

Historic Preservation Division, New Mexico Department of Cultural Affairs

For HPD Office use only: HCPI No. _____ District No. _____		<i>Please complete HCPI FORM 1 before completing FORM 2</i>			
		NRHP	SRCP	Criteria A B C D	
1. Name of property: Frank and Alma Hudson House/ Robert and Mary Neidorf Residence	2. Location: 433 Camino la Paz Downtown and Eastside Historic District – Santa Fe	3. Local Reference Number: Santa Fe ID: H-641			
		4. County: Santa Fe			
		5. Date of Survey: May 28, 2025			

the 1912 King’s map, this house stands as the oldest documented dwelling in the immediate area² (Fig. 1).

In 1920, John Quincy Adams, a mechanic originally from Muskegon, Michigan, acquired Waffensmith’s orchard and formally platted it as the *Los Arboles* (The Trees) Subdivision, dividing the former orchard into smaller residential lots. Adams joined a growing cadre of local investors and developers—notably real estate speculator Harry Dorman—who saw promise (and profit) in transforming the historic Hispanic agricultural long lots along the acequia into small suburban enclaves.

This pattern of land conversion mirrored a broader shift in early 20th-century Santa Fe, as irrigated fields were systematically repurposed to accommodate the city’s quiet but steady residential spread. Among those drawn into this suburban transformation was Agustin A. Sosaya, a modest-scale builder known for his work in Pueblo and Territorial styles. Alongside Favian Chavez and E. G. Richardson—both of whom owned parcels along what would become Calle la Paz³—Sosaya helped develop a cluster of houses on San Antonio Street, offering a picturesque, if somewhat idealized, blend of local architectural traditions.

But Calle la Paz and its neighbor, Camino Manzano, developed differently—with larger lots, more heterogeneous designs, and houses that did not always face the street.

The Hudson Place

A 1928 deed shows that E. G. Richardson sold the parcel containing the subject house to Frank Lawson Hudson and his wife, Alma Hudson.⁴ Frank, born in Mississippi in 1900, worked as a United States Postal Service letter carrier in his home state before being transferred in the late 1920s.

² The King’s map indicates that the long strip of land containing the current parcel was then owned by the Christian Brothers, a Roman Catholic male order in charge of educational instruction, who established St. Michael’s College.

³ James C. Harvey, “Tract of Land Subdivided for A. A. Sosaya, Favian Chavez, E. G. Richardson, Precinct #3, Santa Fe, N. M. [subdivision plat map],” March 31, 1927.

⁴ Agreement, E. G. and Ethel M. Richardson to Frank L. and Alm D. Hudson, recorded January 2, 1929, Book V, Page 115, Instrument #1929036716, Santa Fe County, New Mexico.

Historic Cultural Properties Inventory (HCPI) Detail Form (FORM 2)

Historic Preservation Division, New Mexico Department of Cultural Affairs

For HPD Office use only: HCPI No. _____		<i>Please complete HCPI FORM 1 before completing FORM 2</i>			
District No. _____	NRHP _____	SRCP _____	Criteria <u> </u> A <u> </u> B <u> </u> C <u> </u> D		
1. Name of property: Frank and Alma Hudson House/ Robert and Mary Neidorf Residence	2. Location: 433 Camino la Paz Downtown and Eastside Historic District – Santa Fe	3. Local Reference Number: Santa Fe ID: H-641			
		4. County: Santa Fe			
		5. Date of Survey: May 28, 2025			

The 1930 census places Hudson in the area now known as Calle la Paz, but does not provide a specific street address.⁵ At that time, Calle la Paz had not yet been formally established as a street, and residents along the dirt road were assigned Acequia Madre addresses. This is confirmed by the 1930 city directory, which lists Hudson’s residence as “716 Acequia Madre (1) rear.”⁶ Street addresses for Calle la Paz first appeared in 1938, placing Hudson at what is now 433 Calle la Paz.⁷

City directories and other sources show the Hudson family residing on the property through the early 1960s. The 1940 census, the first to record them at this location, lists Frank Hudson as the owner of the house, then valued at \$4,800.⁸ The household included Frank, age 39; Alma, 43, also born in Mississippi; and their son, Frank Jr., age 8, a New Mexico native.

A February 16, 1942 draft registration card offers a few more glimpses of Frank Hudson. At that time, he was still working as a clerk at the downtown post office under Postmaster Antonio F. Martinez.⁹ As a postal employee, he received his mail in the “Clerk’s Box,” a detail as routine as it is revealing. The registration card notes that he stood 5 feet 11 inches tall, weighed 133 pounds, and was mostly bald.

By the mid-1950s, Frank had advanced to superintendent of the new Coronado Station Post Office, housed in the Your Foods Super Shopping Center. The shopping center was Santa Fe’s first suburban retail experiment, drawn up by Truman Mathews, a former draftsman in John Gaw Meem’s office. By then, the Hudson household had expanded to include Frank, Alma, Frank Jr., and Frank’s widowed mother, Frances.¹⁰

⁵ U.S. Census Bureau, Year: 1930; Census Place: Santa Fe, Santa Fe, New Mexico; Page: 7B; Enumeration District: 0003; FHL microfilm: 2341134.

⁶ Hudspeth Directory Company, *Hudspeth Directory Company*, Santa Fe City Directory, 1930 (El Paso: Hudspeth Directory Company, 1930), 105.

⁷ The street name originally included a “de,” appearing as Calle de la Paz, a form that persisted through the late 1960s.

⁸ U.S. Census Bureau, Year: 1940; Census Place: Santa Fe, Santa Fe, New Mexico; Roll: m-t0627-02452; Page: 61B; Enumeration District: 25-5A.

⁹ National Archives at St. Louis; St. Louis, Missouri; WWII Draft Registration Cards For New Mexico, 10/16/1940-03/31/1947; Record Group: Records of the Selective Service System, 147; Box: 58.

¹⁰ Hudspeth Directory Company, *Hudspeth Directory Company*, Santa Fe City Directory, 1930 (El Paso: Hudspeth Directory Company, 1930), 105.

Historic Cultural Properties Inventory (HCPI) Detail Form (FORM 2)

Historic Preservation Division, New Mexico Department of Cultural Affairs

For HPD Office use only:		Please complete HCPI FORM 1 before completing FORM 2			
HCPI No.	District No.	NRHP	SRCP	Criteria A B C D	
1. Name of property: Frank and Alma Hudson House/ Robert and Mary Neidorf Residence		2. Location: 433 Camino la Paz Downtown and Eastside Historic District – Santa Fe		3. Local Reference Number: Santa Fe ID: H-641	
				4. County: Santa Fe	
				5. Date of Survey: May 28, 2025	

After 37 years in the postal service—a career built on routine, reliability, and careful increments of promotion—Frank retired in August 1960. He and Alma left Santa Fe and moved to Kingsland, Texas, a quiet town in the Hill Country. They died within a month of each other in 1970, closing a story that began in Mississippi, ended in Texas, and included a thirty-year interlude in Santa Fe.

A Home for Tutors

The underlying ownership of the property during this period is unclear, but city directories indicate it was used as a rental. In 1964, Stephen J. Etzald, an insurance adjuster, and his wife, Juxi, rented the home.¹¹ Three years later, it was leased by Harvey L. Mead III and his wife, Claire. Harvey had joined the faculty of St. John’s College a year earlier, where he taught philosophy—serving as a “tutor,” in St. John’s parlance.¹² The small private college would also supply the next tenant, and eventual owner, Robert A. Neidorf. He was also a tutor.

Neidorf, born in Chicago in 1930, received his B.A. and M.A. from the University of Chicago and his Ph.D. from Yale University.¹³ He served as an assistant professor at Bucknell University in Pennsylvania and later taught at the State University of New York at Binghamton. Neidorf joined St. John’s College in Annapolis in 1964 before transferring to the Santa Fe faculty in 1967. That same year, Harper and Row published his book *Deductive Forms: An Elementary Logic*, intended as an introduction to general logic. The book began with a quotation from René Descartes, continued for 407 pages, and was issued only in a single edition. Santa Fe would be his home.

Robert and his wife, Mary Frances Morris Neidorf, acquired the property in 1972; the following year, he was appointed dean of the college.¹⁴ Robert Allen Neidorf died in 1988 at age 57. Mary Frances remained at the house on Calle la Paz until 2000, when she sold the property to Lee Dirks, who held it until recently.

¹¹ Ibid., (1964), 38 and 131.

¹² R.L. Polk & Co., *Santa Fe City Directory, 1967* (Dallas: R.L. Polk & Co., 1967), 45 and 310.

¹³ “Neidorf, Robert Allen” [obituary], *The New Mexican*, February 5, 1988, A-4.

¹⁴ Warranty Deed, Harold D. and Gracia S. Bruce to Mary M. and Robert Neidorf, recorded November 13, 1972, Book 205, Page 308, Instrument # 348546, Santa Fe County, New Mexico.

Historic Cultural Properties Inventory (HCPI) Detail Form (FORM 2)

Historic Preservation Division, New Mexico Department of Cultural Affairs

For HPD Office use only:		<i>Please complete HCPI FORM 1 before completing FORM 2</i>			
HCPI No. _____	District No. _____	NRHP _____	SRCP _____	Criteria <u> </u> A <u> </u> B <u> </u> C <u> </u> D	
1. Name of property: Frank and Alma Hudson House/ Robert and Mary Neidorf Residence	2. Location: 433 Camino la Paz Downtown and Eastside Historic District – Santa Fe	3. Local Reference Number: Santa Fe ID: H-641			
		4. County: Santa Fe			
		5. Date of Survey: May 28, 2025			

Evaluation of Historical Status

Primary House

The primary house is designated as a Contributing Structure to the Downtown and Eastside Historic District. Its most important façade is the front (north-facing) elevation, which has been the least affected by additions and clearly communicates the building’s original and historical character. Character-defining features of this façade include its original horizontal massing, window openings containing older two-over-one wood sash windows, and the brick cornice. By contrast, the east and south elevations are the most altered and have little architectural integrity. For these reasons, it is recommended that the house maintain its Contributing status, with the north elevation designated as the primary façade, specifically the portions that retain original design and materials.

Guesthouse

The guesthouse is primarily a creation of the 1980s and represents a poor example of a clerestory passive solar structure. Better examples of solar design can be found elsewhere in Santa Fe, including within city-designated historic districts. Accordingly, the recommendation is to assign it Non-contributing status.

Garage

The garage is at least 50 years old and represents a good example of its type. The recommendation is to assign it Contributing status, with the west elevation designated as the primary façade.

Walls and Fences

The walls and fences on the site are less than 50 years old and are not recommended for historical status.

Historic Cultural Properties Inventory (HCPI) Detail Form (FORM 2)

Historic Preservation Division, New Mexico Department of Cultural Affairs

For HPD Office use only:		<i>Please complete HCPI FORM 1 before completing FORM 2</i>			
HCPI No.	District No.	NRHP	SRCP	Criteria <u> </u> A <u> </u> B <u> </u> C <u> </u> D	
1. Name of property: Frank and Alma Hudson House/ Robert and Mary Neidorf Residence	2. Location: 433 Camino la Paz Downtown and Eastside Historic District – Santa Fe	3. Local Reference Number: Santa Fe ID: H-641			
		4. County: Santa Fe			
		5. Date of Survey: May 28, 2025			

Illustrations

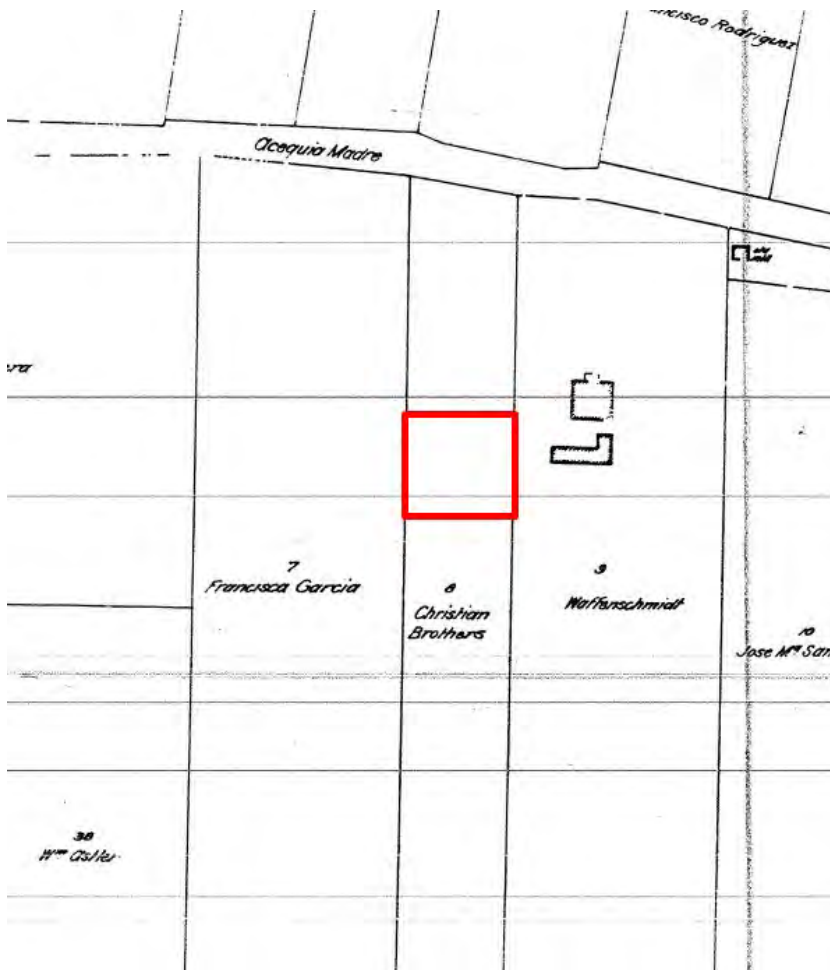

Figure 1: N. L. King, “Official Map of the City of Santa Fe,” 1912.
 The approximate location of the current lot is shown based on its alignment with the Waffenschmidt/Waffensmith house. However, both structures appear to be situated farther south of Acequia Madre than indicated on the map.

Historic Cultural Properties Inventory (HCPI) Detail Form (FORM 2)

Historic Preservation Division, New Mexico Department of Cultural Affairs

For HPD Office use only:		Please complete HCPI FORM 1 before completing FORM 2			
HCPI No.	District No.	NRHP	SRCP	Criteria <u> </u> <u> </u> <u> </u> <u> </u>	
1. Name of property: Frank and Alma Hudson House/ Robert and Mary Neidorf Residence	2. Location: 433 Camino la Paz Downtown and Eastside Historic District - Santa Fe	3. Local Reference Number: Santa Fe ID: H-641			
		4. County: Santa Fe			
		5. Date of Survey: May 28, 2025			

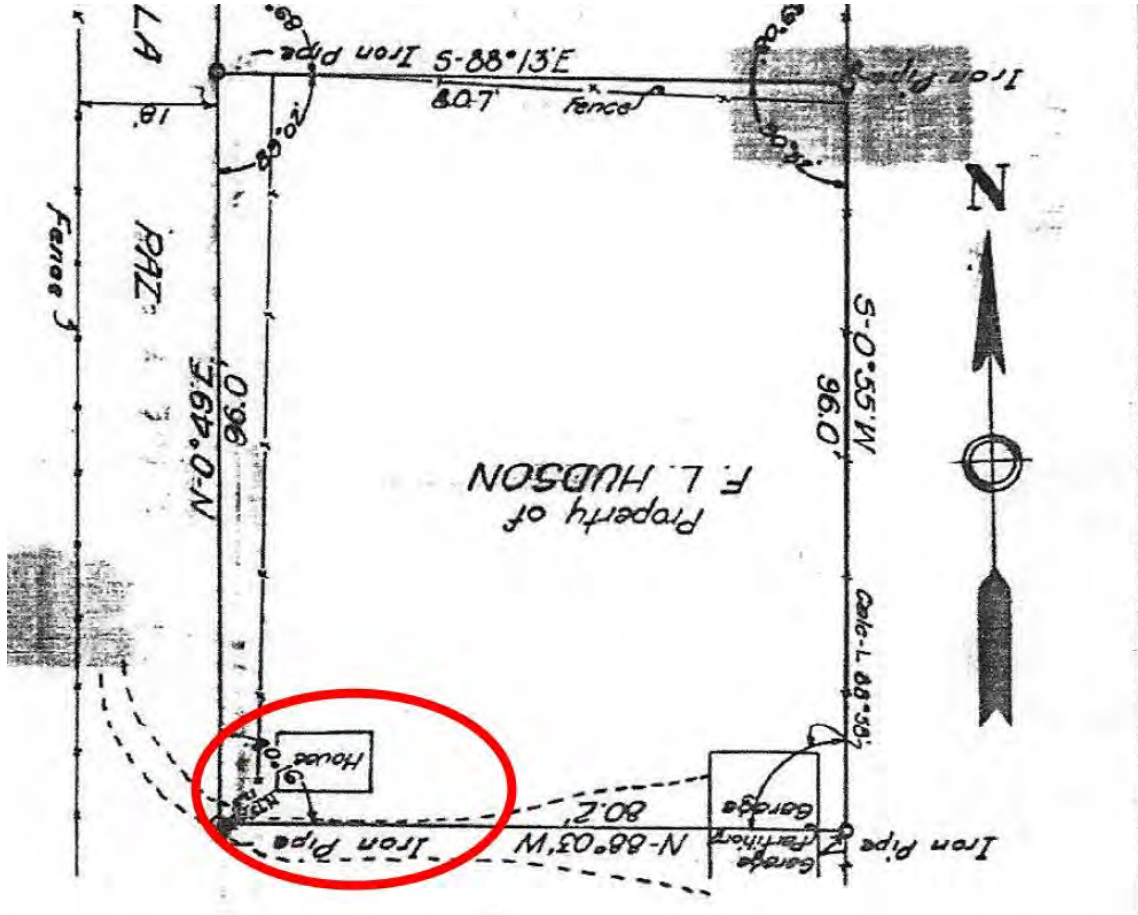

Figure 2: Portion of March 29, 1930, subdivision map. James C. Harvey, creator. Assumed subject house circled.

Historic Cultural Properties Inventory (HCPI) Detail Form (FORM 2)

Historic Preservation Division, New Mexico Department of Cultural Affairs

For HPD Office use only:		<i>Please complete HCPI FORM 1 before completing FORM 2</i>		
HCPI No. _____	District No. _____	NRHP _____	SRCP _____	Criteria <u> </u> A <u> </u> B <u> </u> C <u> </u> D
1. Name of property: Frank and Alma Hudson House/ Robert and Mary Neidorf Residence	2. Location: 433 Camino la Paz Downtown and Eastside Historic District – Santa Fe	3. Local Reference Number: Santa Fe ID: H-641		
		4. County: Santa Fe		
		5. Date of Survey: May 28, 2025		



Figure 3: November 10, 1958, aerial photograph.
Arrow: The addition of what is now holding the kitchen. The closet-bathroom addition has yet to be constructed.

Historic Cultural Properties Inventory (HCPI) Detail Form (FORM 2)

Historic Preservation Division, New Mexico Department of Cultural Affairs

For HPD Office use only:		<i>Please complete HCPI FORM 1 before completing FORM 2</i>		
HCPI No. _____	District No. _____	NRHP _____	SRCP _____	Criteria <u> </u> A <u> </u> B <u> </u> C <u> </u> D
1. Name of property: Frank and Alma Hudson House/ Robert and Mary Neidorf Residence	2. Location: 433 Camino la Paz Downtown and Eastside Historic District – Santa Fe	3. Local Reference Number: Santa Fe ID: H-641		
		4. County: Santa Fe		
		5. Date of Survey: May 28, 2025		



Figure 4: May 2, 1966, aerial photograph.
Arrows: Top, existence of one-car garage; right, existence of small structure that might be incorporated into the current guesthouse. The closet-bathroom addition has yet to be constructed.

Historic Cultural Properties Inventory (HCPI) Detail Form (FORM 2)

Historic Preservation Division, New Mexico Department of Cultural Affairs

For HPD Office use only: HCPI No. _____ District No. _____		<i>Please complete HCPI FORM 1 before completing FORM 2</i> NRHP _____ SRCP _____ Criteria <u> </u> A <u> </u> B <u> </u> C <u> </u> D	
1. Name of property: Frank and Alma Hudson House/ Robert and Mary Neidorf Residence	2. Location: 433 Camino la Paz Downtown and Eastside Historic District – Santa Fe	3. Local Reference Number: Santa Fe ID: H-641	
		4. County: Santa Fe	
		5. Date of Survey: May 28, 2025	



May 11, 1973, aerial photograph.
Arrow: The closet-bathroom addition has been constructed.

Historic Cultural Properties Inventory (HCPI) Detail Form (FORM 2)

Historic Preservation Division, New Mexico Department of Cultural Affairs

For HPD Office use only: HCPI No. _____ District No. _____		Please complete HCPI FORM 1 before completing FORM 2 NRHP _____ SRCP _____ Criteria <u> </u> A <u> </u> B <u> </u> C <u> </u> D	
1. Name of property: Frank and Alma Hudson House/ Robert and Mary Neidorf Residence	2. Location: 433 Camino la Paz Downtown and Eastside Historic District – Santa Fe	3. Local Reference Number: Santa Fe ID: H-641	
		4. County: Santa Fe	
		5. Date of Survey: May 28, 2025	

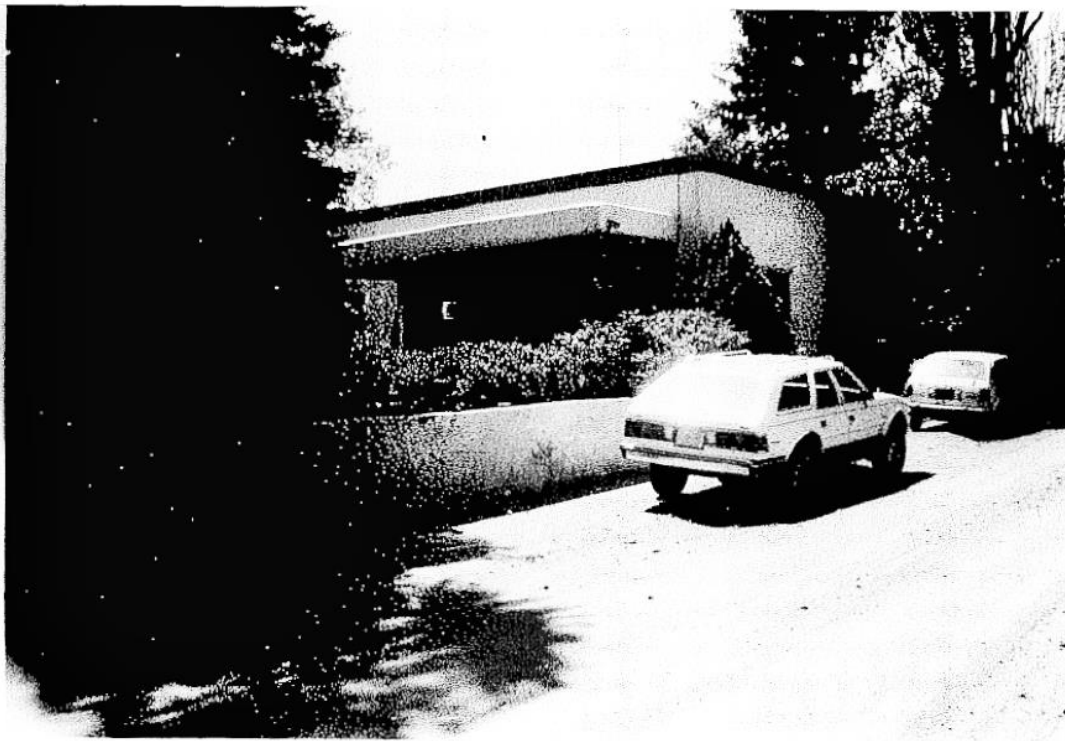

Figure 6: Copy of July 6, 1983, HBI survey photograph. Michael Belshaw.

Historic Cultural Properties Inventory (HCPI) Detail Form (FORM 2)
Historic Preservation Division, New Mexico Department of Cultural Affairs

For HPD Office use only:		<i>Please complete HCPI FORM 1 before completing FORM 2</i>		
HCPI No. _____	District No. _____	NRHP _____	SRCP _____	Criteria <u> </u> A <u> </u> B <u> </u> C <u> </u> D
1. Name of property: Frank and Alma Hudson House/ Robert and Mary Neidorf Residence	2. Location: 433 Camino la Paz Downtown and Eastside Historic District – Santa Fe	3. Local Reference Number: Santa Fe ID: H-641		
		4. County: Santa Fe		
		5. Date of Survey: May 28, 2025		

Survey Photographs

(All images taken by John W. Murphey, May 28, 2025)



Photo 2: West yard/privacy wall. Camera facing southeast.

Historic Cultural Properties Inventory (HCPI) Detail Form (FORM 2)

Historic Preservation Division, New Mexico Department of Cultural Affairs

For HPD Office use only: HCPI No. _____ District No. _____		<i>Please complete HCPI FORM 1 before completing FORM 2</i> NRHP _____ SRCP _____ Criteria <u> </u> A <u> </u> B <u> </u> C <u> </u> D	
1. Name of property: Frank and Alma Hudson House/ Robert and Mary Neidorf Residence	2. Location: 433 Camino la Paz Downtown and Eastside Historic District – Santa Fe	3. Local Reference Number: Santa Fe ID: H-641	
		4. County: Santa Fe	
		5. Date of Survey: May 28, 2025	



Photo 3: Primary House, north elevation. Camera facing south.

Historic Cultural Properties Inventory (HCPI) Detail Form (FORM 2)

Historic Preservation Division, New Mexico Department of Cultural Affairs

For HPD Office use only: HCPI No. _____ District No. _____		<i>Please complete HCPI FORM 1 before completing FORM 2</i> NRHP _____ SRCP _____ Criteria <u> </u> A <u> </u> B <u> </u> C <u> </u> D	
1. Name of property: Frank and Alma Hudson House/ Robert and Mary Neidorf Residence	2. Location: 433 Camino la Paz Downtown and Eastside Historic District – Santa Fe	3. Local Reference Number: Santa Fe ID: H-641	
		4. County: Santa Fe	
		5. Date of Survey: May 28, 2025	



Photo 4: Primary House, north elevation. Portal. Camera facing west.

Historic Cultural Properties Inventory (HCPI) Detail Form (FORM 2)

Historic Preservation Division, New Mexico Department of Cultural Affairs

For HPD Office use only: HCPI No. _____ District No. _____		<i>Please complete HCPI FORM 1 before completing FORM 2</i> NRHP _____ SRCP _____ Criteria <u> </u> A <u> </u> B <u> </u> C <u> </u> D	
1. Name of property: Frank and Alma Hudson House/ Robert and Mary Neidorf Residence	2. Location: 433 Camino la Paz Downtown and Eastside Historic District – Santa Fe	3. Local Reference Number: Santa Fe ID: H-641	
		4. County: Santa Fe	
		5. Date of Survey: May 28, 2025	



Photo 5: Primary House, north elevation. Entry door. Camera facing south.

Historic Cultural Properties Inventory (HCPI) Detail Form (FORM 2)

Historic Preservation Division, New Mexico Department of Cultural Affairs

For HPD Office use only: HCPI No. _____ District No. _____		<i>Please complete HCPI FORM 1 before completing FORM 2</i> NRHP _____ SRCP _____ Criteria <u> </u> A <u> </u> B <u> </u> C <u> </u> D	
1. Name of property: Frank and Alma Hudson House/ Robert and Mary Neidorf Residence	2. Location: 433 Camino la Paz Downtown and Eastside Historic District – Santa Fe	3. Local Reference Number: Santa Fe ID: H-641	
		4. County: Santa Fe	
		5. Date of Survey: May 28, 2025	



Photo 6: Primary House, north elevation. Entry door threshold. Camera facing down.

Historic Cultural Properties Inventory (HCPI) Detail Form (FORM 2)

Historic Preservation Division, New Mexico Department of Cultural Affairs

For HPD Office use only:		<i>Please complete HCPI FORM 1 before completing FORM 2</i>		
HCPI No. _____	District No. _____	NRHP _____	SRCP _____	Criteria <u> </u> A <u> </u> B <u> </u> C <u> </u> D
1. Name of property: Frank and Alma Hudson House/ Robert and Mary Neidorf Residence	2. Location: 433 Camino la Paz Downtown and Eastside Historic District – Santa Fe	3. Local Reference Number: Santa Fe ID: H-641		
		4. County: Santa Fe		
		5. Date of Survey: May 28, 2025		

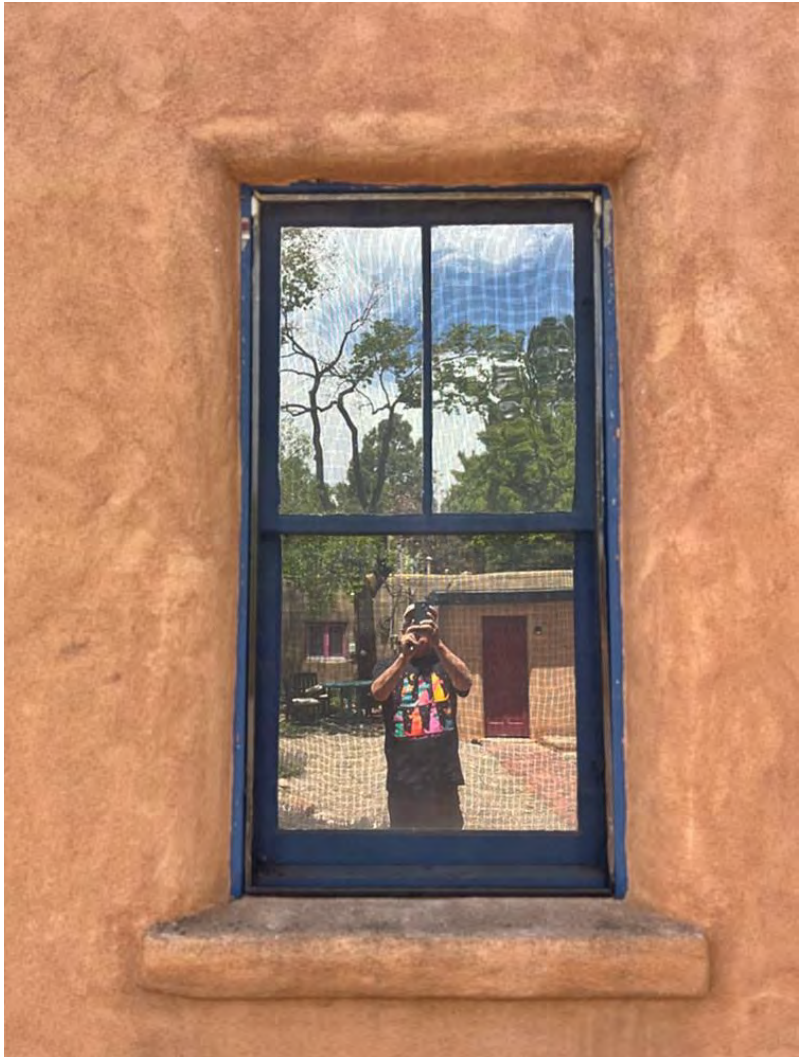

Photo 7: Primary House, north elevation. East window. Camera facing south.

Historic Cultural Properties Inventory (HCPI) Detail Form (FORM 2)

Historic Preservation Division, New Mexico Department of Cultural Affairs

For HPD Office use only: HCPI No. _____ District No. _____		Please complete HCPI FORM 1 before completing FORM 2 NRHP _____ SRCP _____ Criteria <u> </u> A <u> </u> B <u> </u> C <u> </u> D	
1. Name of property: Frank and Alma Hudson House/ Robert and Mary Neidorf Residence	2. Location: 433 Camino la Paz Downtown and Eastside Historic District – Santa Fe	3. Local Reference Number: Santa Fe ID: H-641	
		4. County: Santa Fe	
		5. Date of Survey: May 28, 2025	



Photo 8: Primary House, north elevation. West window detail. Camera facing down.

Historic Cultural Properties Inventory (HCPI) Detail Form (FORM 2)

Historic Preservation Division, New Mexico Department of Cultural Affairs

For HPD Office use only: HCPI No. _____ District No. _____		<i>Please complete HCPI FORM 1 before completing FORM 2</i> NRHP _____ SRCP _____ Criteria <u> </u> A <u> </u> B <u> </u> C <u> </u> D	
1. Name of property: Frank and Alma Hudson House/ Robert and Mary Neidorf Residence	2. Location: 433 Camino la Paz Downtown and Eastside Historic District – Santa Fe	3. Local Reference Number: Santa Fe ID: H-641	
		4. County: Santa Fe	
		5. Date of Survey: May 28, 2025	



Photo 9: Primary House, north elevation. West. Camera facing north.

Historic Cultural Properties Inventory (HCPI) Detail Form (FORM 2)

Historic Preservation Division, New Mexico Department of Cultural Affairs

For HPD Office use only: HCPI No. _____ District No. _____		<i>Please complete HCPI FORM 1 before completing FORM 2</i> NRHP _____ SRCP _____ Criteria <u> </u> A <u> </u> B <u> </u> C <u> </u> D	
1. Name of property: Frank and Alma Hudson House/ Robert and Mary Neidorf Residence	2. Location: 433 Camino la Paz Downtown and Eastside Historic District – Santa Fe	3. Local Reference Number: Santa Fe ID: H-641	
		4. County: Santa Fe	
		5. Date of Survey: May 28, 2025	



Photo 10: Primary House, west elevation. Camera facing south.

Historic Cultural Properties Inventory (HCPI) Detail Form (FORM 2)

Historic Preservation Division, New Mexico Department of Cultural Affairs

For HPD Office use only: HCPI No. _____ District No. _____		<i>Please complete HCPI FORM 1 before completing FORM 2</i> NRHP _____ SRCP _____ Criteria <u> </u> A <u> </u> B <u> </u> C <u> </u> D	
1. Name of property: Frank and Alma Hudson House/ Robert and Mary Neidorf Residence	2. Location: 433 Camino la Paz Downtown and Eastside Historic District – Santa Fe	3. Local Reference Number: Santa Fe ID: H-641	
		4. County: Santa Fe	
		5. Date of Survey: May 28, 2025	



Photo 11: Primary House, west elevation. North windows. Camera facing east.

Historic Cultural Properties Inventory (HCPI) Detail Form (FORM 2)

Historic Preservation Division, New Mexico Department of Cultural Affairs

For HPD Office use only:		<i>Please complete HCPI FORM 1 before completing FORM 2</i>		
HCPI No. _____	District No. _____	NRHP _____	SRCP _____	Criteria <u> </u> A <u> </u> B <u> </u> C <u> </u> D
1. Name of property: Frank and Alma Hudson House/ Robert and Mary Neidorf Residence	2. Location: 433 Camino la Paz Downtown and Eastside Historic District – Santa Fe	3. Local Reference Number: Santa Fe ID: H-641		
		4. County: Santa Fe		
		5. Date of Survey: May 28, 2025		



Photo 12: Primary House, west elevation. South windows. Camera facing east.

Historic Cultural Properties Inventory (HCPI) Detail Form (FORM 2)

Historic Preservation Division, New Mexico Department of Cultural Affairs

For HPD Office use only: HCPI No. _____ District No. _____		<i>Please complete HCPI FORM 1 before completing FORM 2</i> NRHP _____ SRCP _____ Criteria <u> </u> A <u> </u> B <u> </u> C <u> </u> D	
1. Name of property: Frank and Alma Hudson House/ Robert and Mary Neidorf Residence	2. Location: 433 Camino la Paz Downtown and Eastside Historic District – Santa Fe	3. Local Reference Number: Santa Fe ID: H-641	
		4. County: Santa Fe	
		5. Date of Survey: May 28, 2025	



Photo 13: Primary House, south elevation. Camera facing east.

Historic Cultural Properties Inventory (HCPI) Detail Form (FORM 2)

Historic Preservation Division, New Mexico Department of Cultural Affairs

For HPD Office use only: HCPI No. _____ District No. _____		<i>Please complete HCPI FORM 1 before completing FORM 2</i> NRHP _____ SRCP _____ Criteria <u> </u> A <u> </u> B <u> </u> C <u> </u> D	
1. Name of property: Frank and Alma Hudson House/ Robert and Mary Neidorf Residence	2. Location: 433 Camino la Paz Downtown and Eastside Historic District – Santa Fe	3. Local Reference Number: Santa Fe ID: H-641	
		4. County: Santa Fe	
		5. Date of Survey: May 28, 2025	



Photo 14: Primary House, south elevation. West window. Camera facing north.

Historic Cultural Properties Inventory (HCPI) Detail Form (FORM 2)

Historic Preservation Division, New Mexico Department of Cultural Affairs

For HPD Office use only: HCPI No. _____ District No. _____		Please complete HCPI FORM 1 before completing FORM 2	
		NRHP _____ SRCP _____	Criteria <u> </u> A <u> </u> B <u> </u> C <u> </u> D
1. Name of property: Frank and Alma Hudson House/ Robert and Mary Neidorf Residence	2. Location: 433 Camino la Paz Downtown and Eastside Historic District – Santa Fe	3. Local Reference Number: Santa Fe ID: H-641	
		4. County: Santa Fe	
		5. Date of Survey: May 28, 2025	



Photo 15: Primary House, south elevation. Middle window. Camera facing north.

Historic Cultural Properties Inventory (HCPI) Detail Form (FORM 2)

Historic Preservation Division, New Mexico Department of Cultural Affairs

For HPD Office use only: HCPI No. _____ District No. _____		<i>Please complete HCPI FORM 1 before completing FORM 2</i> NRHP _____ SRCP _____ Criteria <u> </u> A <u> </u> B <u> </u> C <u> </u> D	
1. Name of property: Frank and Alma Hudson House/ Robert and Mary Neidorf Residence	2. Location: 433 Camino la Paz Downtown and Eastside Historic District – Santa Fe	3. Local Reference Number: Santa Fe ID: H-641	
		4. County: Santa Fe	
		5. Date of Survey: May 28, 2025	



Photo 16: Primary House, east elevation. Camera facing west.

Historic Cultural Properties Inventory (HCPI) Detail Form (FORM 2)

Historic Preservation Division, New Mexico Department of Cultural Affairs

For HPD Office use only: HCPI No. _____ District No. _____		<i>Please complete HCPI FORM 1 before completing FORM 2</i> NRHP _____ SRCP _____ Criteria <u> </u> A <u> </u> B <u> </u> C <u> </u> D	
1. Name of property: Frank and Alma Hudson House/ Robert and Mary Neidorf Residence	2. Location: 433 Camino la Paz Downtown and Eastside Historic District – Santa Fe	3. Local Reference Number: Santa Fe ID: H-641	
		4. County: Santa Fe	
		5. Date of Survey: May 28, 2025	



Photo 17: Primary House, east elevation. Entry to kitchen. Camera facing west.

Historic Cultural Properties Inventory (HCPI) Detail Form (FORM 2)

Historic Preservation Division, New Mexico Department of Cultural Affairs

For HPD Office use only:		<i>Please complete HCPI FORM 1 before completing FORM 2</i>		
HCPI No. _____	District No. _____	NRHP _____	SRCP _____	Criteria <u> </u> A <u> </u> B <u> </u> C <u> </u> D
1. Name of property: Frank and Alma Hudson House/ Robert and Mary Neidorf Residence	2. Location: 433 Camino la Paz Downtown and Eastside Historic District – Santa Fe	3. Local Reference Number: Santa Fe ID: H-641		
		4. County: Santa Fe		
		5. Date of Survey: May 28, 2025		



Photo 18: Primary House, east elevation. Window at closet. Camera facing east.

Historic Cultural Properties Inventory (HCPI) Detail Form (FORM 2)

Historic Preservation Division, New Mexico Department of Cultural Affairs

For HPD Office use only: HCPI No. _____ District No. _____		<i>Please complete HCPI FORM 1 before completing FORM 2</i> NRHP _____ SRCP _____ Criteria <u> </u> A <u> </u> B <u> </u> C <u> </u> D	
1. Name of property: Frank and Alma Hudson House/ Robert and Mary Neidorf Residence	2. Location: 433 Camino la Paz Downtown and Eastside Historic District – Santa Fe	3. Local Reference Number: Santa Fe ID: H-641	
		4. County: Santa Fe	
		5. Date of Survey: May 28, 2025	



Photo 19: Primary House, interior of front room. Camera facing west.

Historic Cultural Properties Inventory (HCPI) Detail Form (FORM 2)

Historic Preservation Division, New Mexico Department of Cultural Affairs

For HPD Office use only: HCPI No. _____ District No. _____		<i>Please complete HCPI FORM 1 before completing FORM 2</i> NRHP _____ SRCP _____ Criteria <u> </u> A <u> </u> B <u> </u> C <u> </u> D	
1. Name of property: Frank and Alma Hudson House/ Robert and Mary Neidorf Residence	2. Location: 433 Camino la Paz Downtown and Eastside Historic District – Santa Fe	3. Local Reference Number: Santa Fe ID: H-641	
		4. County: Santa Fe	
		5. Date of Survey: May 28, 2025	



Photo 20: Primary House, interior of primary bedroom. Camera facing west.

Historic Cultural Properties Inventory (HCPI) Detail Form (FORM 2)

Historic Preservation Division, New Mexico Department of Cultural Affairs

For HPD Office use only:		<i>Please complete HCPI FORM 1 before completing FORM 2</i>		
HCPI No.	District No.	NRHP	SRCP	Criteria <u> </u> A <u> </u> B <u> </u> C <u> </u> D
1. Name of property: Frank and Alma Hudson House/ Robert and Mary Neidorf Residence	2. Location: 433 Camino la Paz Downtown and Eastside Historic District – Santa Fe	3. Local Reference Number: Santa Fe ID: H-641		
		4. County: Santa Fe		
		5. Date of Survey: May 28, 2025		



Photo 21: Primary House, interior of bathroom addition. Camera facing south.

Historic Cultural Properties Inventory (HCPI) Detail Form (FORM 2)

Historic Preservation Division, New Mexico Department of Cultural Affairs

For HPD Office use only: HCPI No. _____ District No. _____		<i>Please complete HCPI FORM 1 before completing FORM 2</i> NRHP _____ SRCP _____ Criteria <u> </u> A <u> </u> B <u> </u> C <u> </u> D	
1. Name of property: Frank and Alma Hudson House/ Robert and Mary Neidorf Residence	2. Location: 433 Camino la Paz Downtown and Eastside Historic District – Santa Fe	3. Local Reference Number: Santa Fe ID: H-641	
		4. County: Santa Fe	
		5. Date of Survey: May 28, 2025	



Photo 22: Primary House, interior of dining room. Camera facing south.

Historic Cultural Properties Inventory (HCPI) Detail Form (FORM 2)

Historic Preservation Division, New Mexico Department of Cultural Affairs

For HPD Office use only: HCPI No. _____ District No. _____		<i>Please complete HCPI FORM 1 before completing FORM 2</i> NRHP _____ SRCP _____ Criteria <u> </u> <u> </u> <u> </u> <u> </u> <u> </u> <u> </u> <u> </u> <u> </u>	
1. Name of property: Frank and Alma Hudson House/ Robert and Mary Neidorf Residence	2. Location: 433 Camino la Paz Downtown and Eastside Historic District – Santa Fe	3. Local Reference Number: Santa Fe ID: H-641	
		4. County: Santa Fe	
		5. Date of Survey: May 28, 2025	



Photo 23: Primary House, interior of second bedroom. Camera facing east.

Historic Cultural Properties Inventory (HCPI) Detail Form (FORM 2)

Historic Preservation Division, New Mexico Department of Cultural Affairs

For HPD Office use only: HCPI No. _____ District No. _____		<i>Please complete HCPI FORM 1 before completing FORM 2</i> NRHP _____ SRCP _____ Criteria <u> </u> A <u> </u> B <u> </u> C <u> </u> D	
1. Name of property: Frank and Alma Hudson House/ Robert and Mary Neidorf Residence	2. Location: 433 Camino la Paz Downtown and Eastside Historic District – Santa Fe	3. Local Reference Number: Santa Fe ID: H-641	
		4. County: Santa Fe	
		5. Date of Survey: May 28, 2025	



Photo 24 : Primary House, interior of kitchen. Camera facing west.

Historic Cultural Properties Inventory (HCPI) Detail Form (FORM 2)

Historic Preservation Division, New Mexico Department of Cultural Affairs

For HPD Office use only: HCPI No. _____ District No. _____		<i>Please complete HCPI FORM 1 before completing FORM 2</i> NRHP _____ SRCP _____ Criteria <u> </u> A <u> </u> B <u> </u> C <u> </u> D		
1. Name of property: Frank and Alma Hudson House/ Robert and Mary Neidorf Residence	2. Location: 433 Camino la Paz Downtown and Eastside Historic District – Santa Fe	3. Local Reference Number: Santa Fe ID: H-641		
		4. County: Santa Fe		
		5. Date of Survey: May 28, 2025		



Photo 25: Guesthouse, west elevation. Camera facing northeast.

Historic Cultural Properties Inventory (HCPI) Detail Form (FORM 2)

Historic Preservation Division, New Mexico Department of Cultural Affairs

For HPD Office use only: HCPI No. _____ District No. _____		<i>Please complete HCPI FORM 1 before completing FORM 2</i> NRHP _____ SRCP _____ Criteria <u> </u> A <u> </u> B <u> </u> C <u> </u> D	
1. Name of property: Frank and Alma Hudson House/ Robert and Mary Neidorf Residence	2. Location: 433 Camino la Paz Downtown and Eastside Historic District – Santa Fe	3. Local Reference Number: Santa Fe ID: H-641	
		4. County: Santa Fe	
		5. Date of Survey: May 28, 2025	



Photo 26: Guesthouse, south elevation. Camera facing north.

Historic Cultural Properties Inventory (HCPI) Detail Form (FORM 2)

Historic Preservation Division, New Mexico Department of Cultural Affairs

For HPD Office use only: HCPI No. _____ District No. _____		<i>Please complete HCPI FORM 1 before completing FORM 2</i> NRHP _____ SRCP _____ Criteria <u> </u> A <u> </u> B <u> </u> C <u> </u> D		
1. Name of property: Frank and Alma Hudson House/ Robert and Mary Neidorf Residence	2. Location: 433 Camino la Paz Downtown and Eastside Historic District – Santa Fe	3. Local Reference Number: Santa Fe ID: H-641		
		4. County: Santa Fe		
		5. Date of Survey: May 28, 2025		



Photo 27: Guesthouse, north elevation. Camera facing west.

Historic Cultural Properties Inventory (HCPI) Detail Form (FORM 2)

Historic Preservation Division, New Mexico Department of Cultural Affairs

For HPD Office use only: <i>Please complete HCPI FORM 1 before completing FORM 2</i>		
HCPI No. _____	District No. _____ NRHP _____ SRCP _____ Criteria <u> </u> A <u> </u> B <u> </u> C <u> </u> D	
1. Name of property: Frank and Alma Hudson House/ Robert and Mary Neidorf Residence	2. Location: 433 Camino la Paz Downtown and Eastside Historic District – Santa Fe	3. Local Reference Number: Santa Fe ID: H-641 4. County: Santa Fe 5. Date of Survey: May 28, 2025



Photo 28: Guesthouse, south elevation. Camera facing south.

Historic Cultural Properties Inventory (HCPI) Detail Form (FORM 2)

Historic Preservation Division, New Mexico Department of Cultural Affairs

For HPD Office use only:		<i>Please complete HCPI FORM 1 before completing FORM 2</i>		
HCPI No. _____	District No. _____	NRHP _____	SRCP _____	Criteria <u> </u> A <u> </u> B <u> </u> C <u> </u> D
1. Name of property: Frank and Alma Hudson House/ Robert and Mary Neidorf Residence	2. Location: 433 Camino la Paz Downtown and Eastside Historic District – Santa Fe	3. Local Reference Number: Santa Fe ID: H-641		
		4. County: Santa Fe		
		5. Date of Survey: May 28, 2025		



Photo 29: Guesthouse, interior of main room. Camera facing north.

Historic Cultural Properties Inventory (HCPI) Detail Form (FORM 2)

Historic Preservation Division, New Mexico Department of Cultural Affairs

For HPD Office use only: HCPI No. _____ District No. _____		<i>Please complete HCPI FORM 1 before completing FORM 2</i> NRHP _____ SRCP _____ Criteria <u> </u> A <u> </u> B <u> </u> C <u> </u> D	
1. Name of property: Frank and Alma Hudson House/ Robert and Mary Neidorf Residence	2. Location: 433 Camino la Paz Downtown and Eastside Historic District – Santa Fe	3. Local Reference Number: Santa Fe ID: H-641	
		4. County: Santa Fe	
		5. Date of Survey: May 28, 2025	



Photo 30: Garage, west elevation. Camera facing east.

Historic Cultural Properties Inventory (HCPI) Detail Form (FORM 2)

Historic Preservation Division, New Mexico Department of Cultural Affairs

For HPD Office use only: HCPI No. _____ District No. _____		<i>Please complete HCPI FORM 1 before completing FORM 2</i> NRHP _____ SRCP _____ Criteria <u> </u> A <u> </u> B <u> </u> C <u> </u> D	
1. Name of property: Frank and Alma Hudson House/ Robert and Mary Neidorf Residence	2. Location: 433 Camino la Paz Downtown and Eastside Historic District – Santa Fe	3. Local Reference Number: Santa Fe ID: H-641	
		4. County: Santa Fe	
		5. Date of Survey: May 28, 2025	



Photo 31: Garage, south and east elevations. Camera facing northwest.

Historic Cultural Properties Inventory (HCPI) Detail Form (FORM 2)

Historic Preservation Division, New Mexico Department of Cultural Affairs

For HPD Office use only: HCPI No. _____ District No. _____		<i>Please complete HCPI FORM 1 before completing FORM 2</i> NRHP _____ SRCP _____ Criteria <u> </u> A <u> </u> B <u> </u> C <u> </u> D	
1. Name of property: Frank and Alma Hudson House/ Robert and Mary Neidorf Residence	2. Location: 433 Camino la Paz Downtown and Eastside Historic District – Santa Fe	3. Local Reference Number: Santa Fe ID: H-641	
		4. County: Santa Fe	
		5. Date of Survey: May 28, 2025	



Photo 32: Garage, east elevation. Window detail. Camera facing west.

Historic Cultural Properties Inventory (HCPI) Detail Form (FORM 2)

Historic Preservation Division, New Mexico Department of Cultural Affairs

For HPD Office use only: HCPI No. _____ District No. _____		<i>Please complete HCPI FORM 1 before completing FORM 2</i> NRHP _____ SRCP _____ Criteria <u> </u> A <u> </u> B <u> </u> C <u> </u> D	
1. Name of property: Frank and Alma Hudson House/ Robert and Mary Neidorf Residence	2. Location: 433 Camino la Paz Downtown and Eastside Historic District – Santa Fe	3. Local Reference Number: Santa Fe ID: H-641	
		4. County: Santa Fe	
		5. Date of Survey: May 28, 2025	



Photo 33: Garage, north elevation. Camera facing southeast.

Historic Cultural Properties Inventory (HCPI) Detail Form (FORM 2)

Historic Preservation Division, New Mexico Department of Cultural Affairs

For HPD Office use only: HCPI No. _____ District No. _____		<i>Please complete HCPI FORM 1 before completing FORM 2</i> NRHP _____ SRCP _____ Criteria <u> </u> A <u> </u> B <u> </u> C <u> </u> D	
1. Name of property: Frank and Alma Hudson House/ Robert and Mary Neidorf Residence	2. Location: 433 Camino la Paz Downtown and Eastside Historic District – Santa Fe	3. Local Reference Number: Santa Fe ID: H-641	
		4. County: Santa Fe	
		5. Date of Survey: May 28, 2025	



Photo 34: East yard/privacy wall along Camino Manzano. Camera facing southeast.

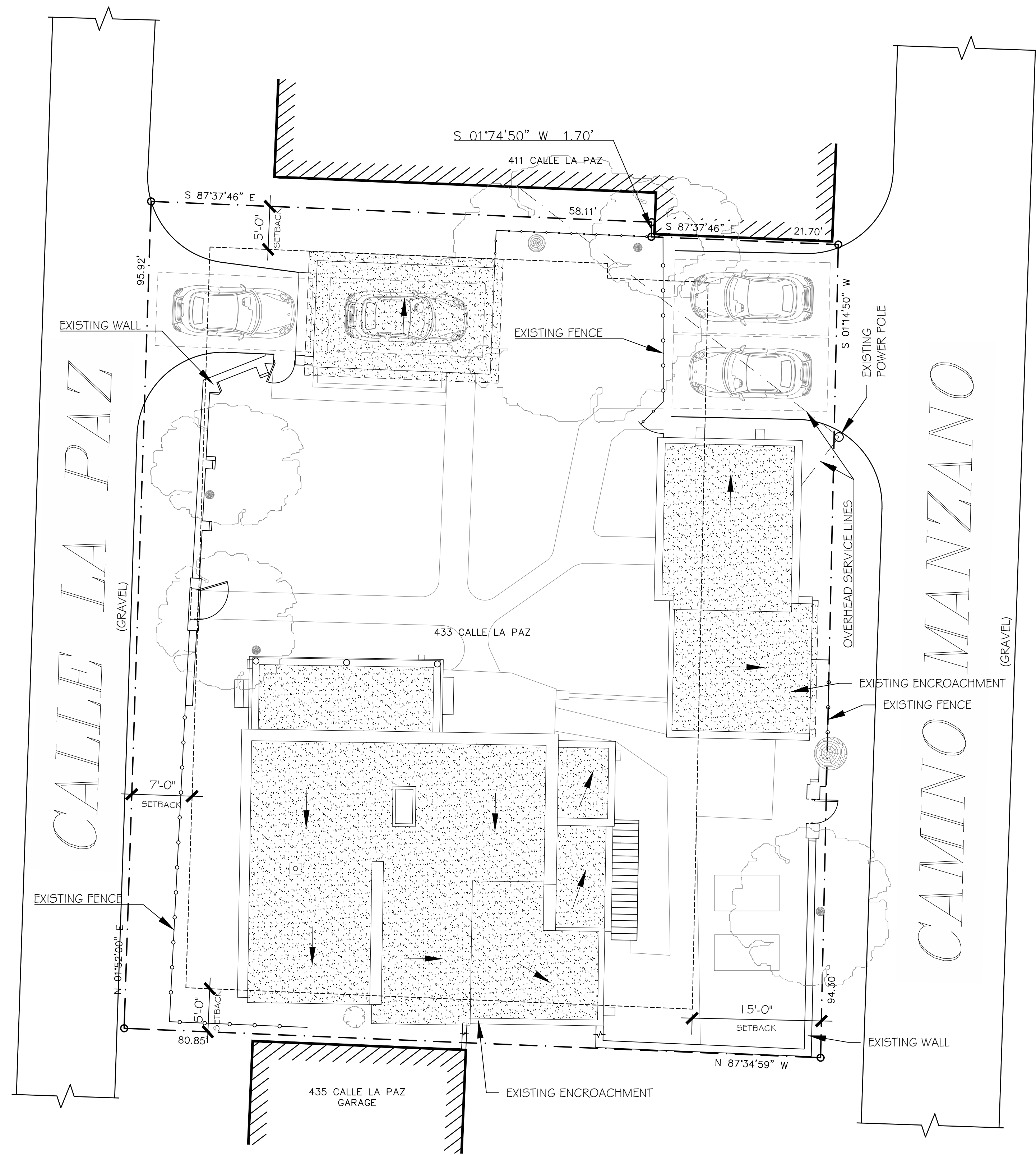

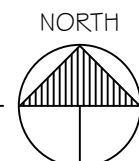
1 EXISTING SITE
 A-1.0 SCALE: 1/8" = 1'-0" 

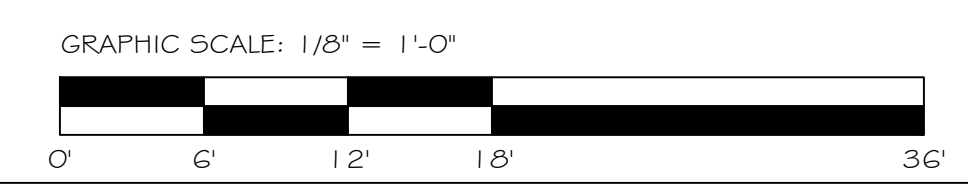

MARTINEZ
 ARCHITECTURE
 STUDIO PC
 1524 PASEO DE PERALTA SANTA FE
 505.989.4958 studio@martinezarch.com

RENOVATION
 433 CALLE LA PAZ
 S ANTONIO, TEXAS
 NEW MEXICO

JULY 3, 2025

EXISTING
 SITE

A
 1.0

SET #
 AUSTIN-GREGORY - 2509

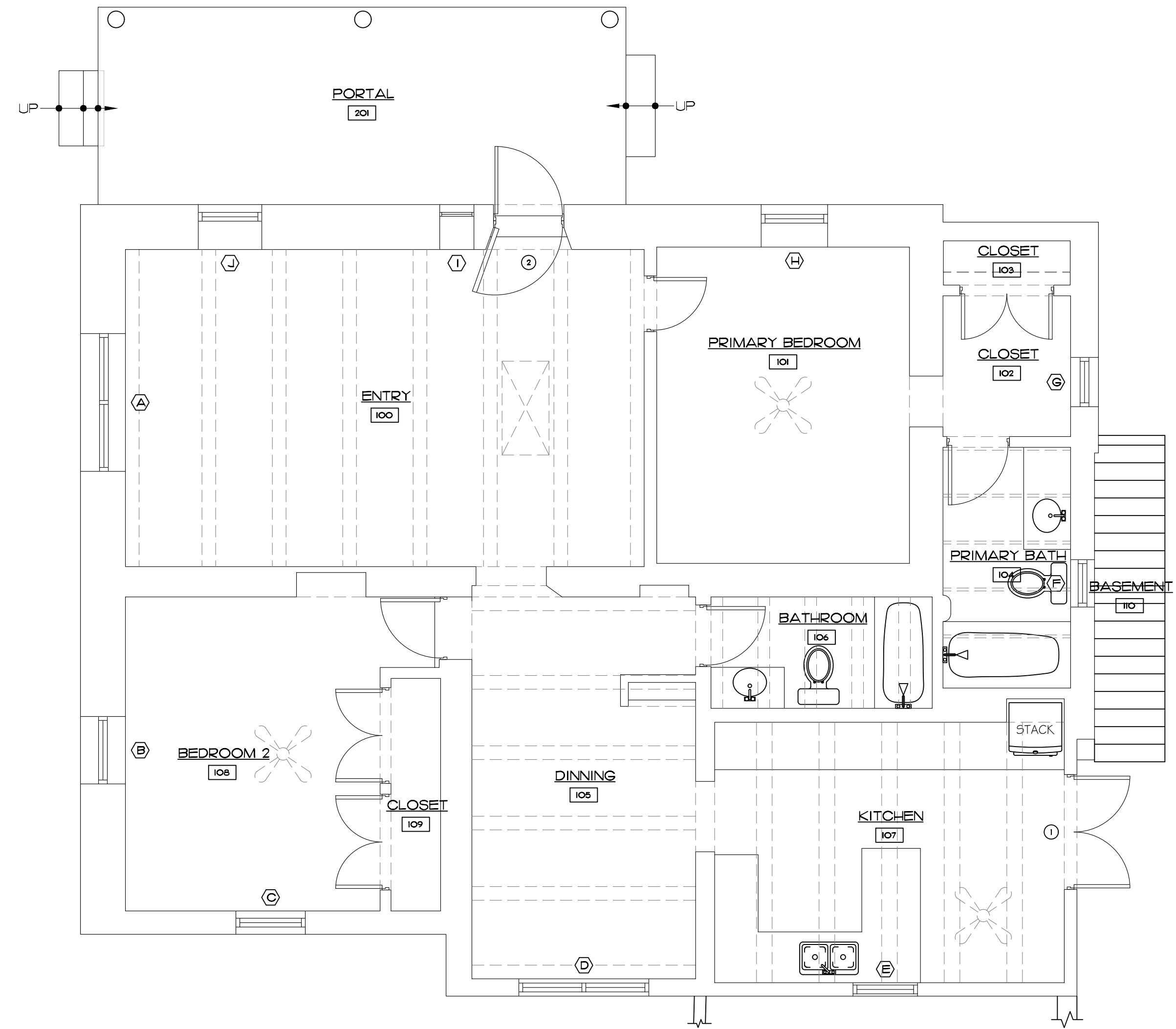

1
A-3.0 EXISTING FLOOR PLAN
SCALE: 1/4" = 1'-0"

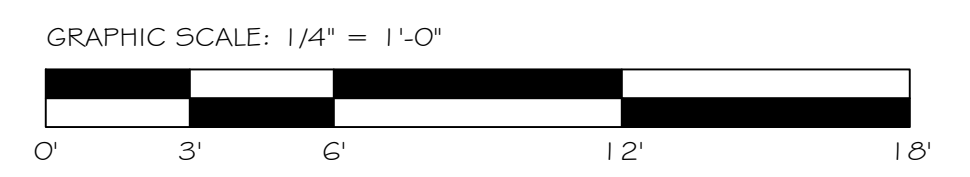

MARTINEZ
ARCHITECTURE
STUDIO PC
1524 PASEO DE PERALTA SANTA FE
505.989.4958 studio@martinezarch.com

RENOVATION
433 CALLE LA PAZ
SANTA FE,
NEW MEXICO

JULY 3, 2025

MAIN
HOUSE -
EXISTING
FLOOR PLAN

A
3.0

SET #
AUSTIN-GREGORY - 2509

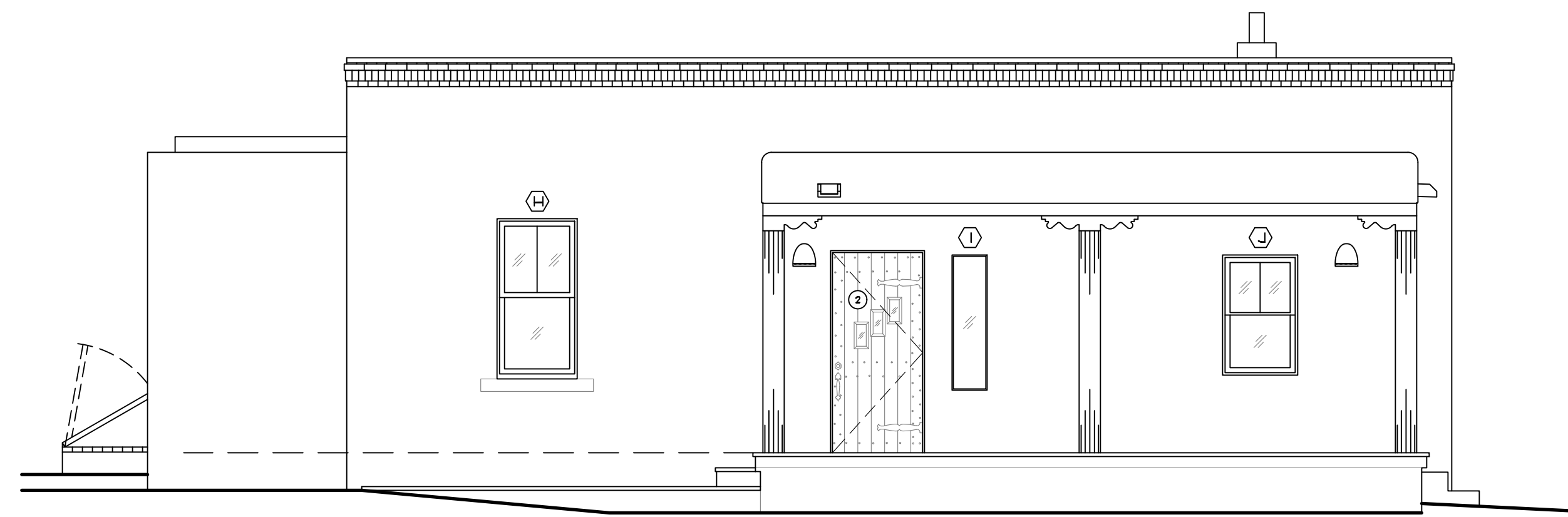

2 EXISTING NORTH ELEVATION
A-4.0 SCALE: 1/4" = 1'-0"

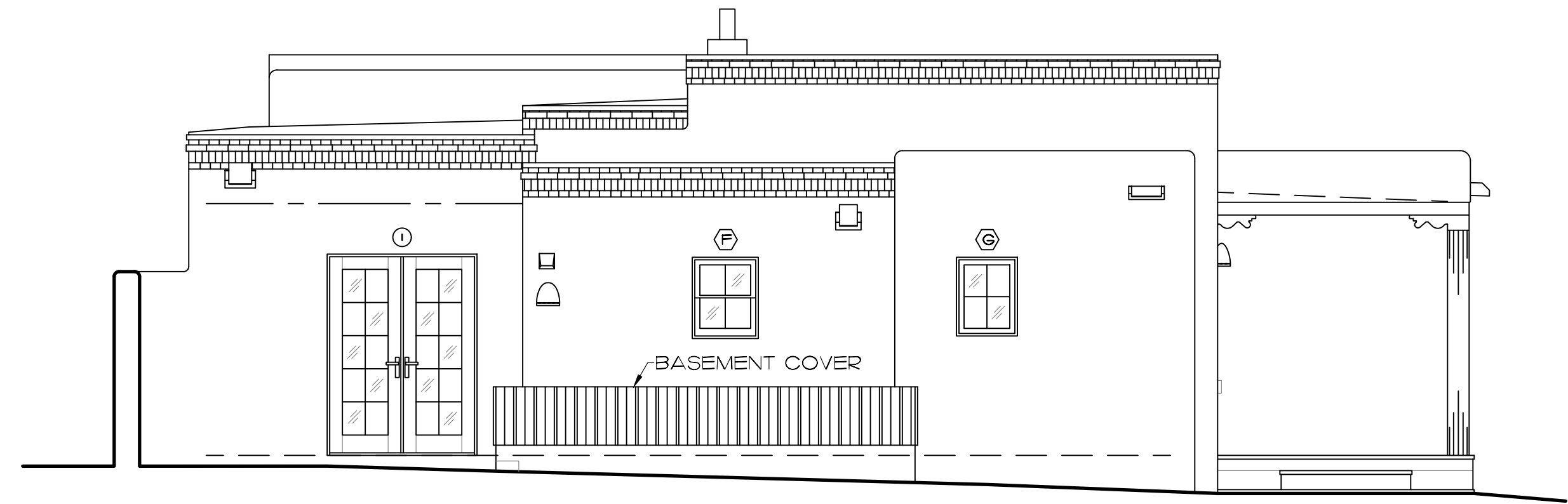

1 EXISTING EAST ELEVATION
A-4.0 SCALE: 1/4" = 1'-0"

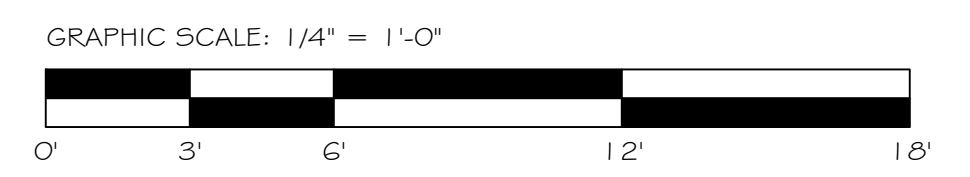

MARTINEZ
ARCHITECTURE
STUDIO PC
1524 PASEO DE PERALTA SANTA FE
505.989.4958 studio@martinezarch.com

RENOVATION
433 CALLE LA PAZ
SANTA FE, NM
NEW MEXICO

JULY 3, 2025

MAIN
HOUSE -
NORTH &
EAST
ELEVATIONS

A
4.0

SET #
AUSTIN-GREGORY - 2509

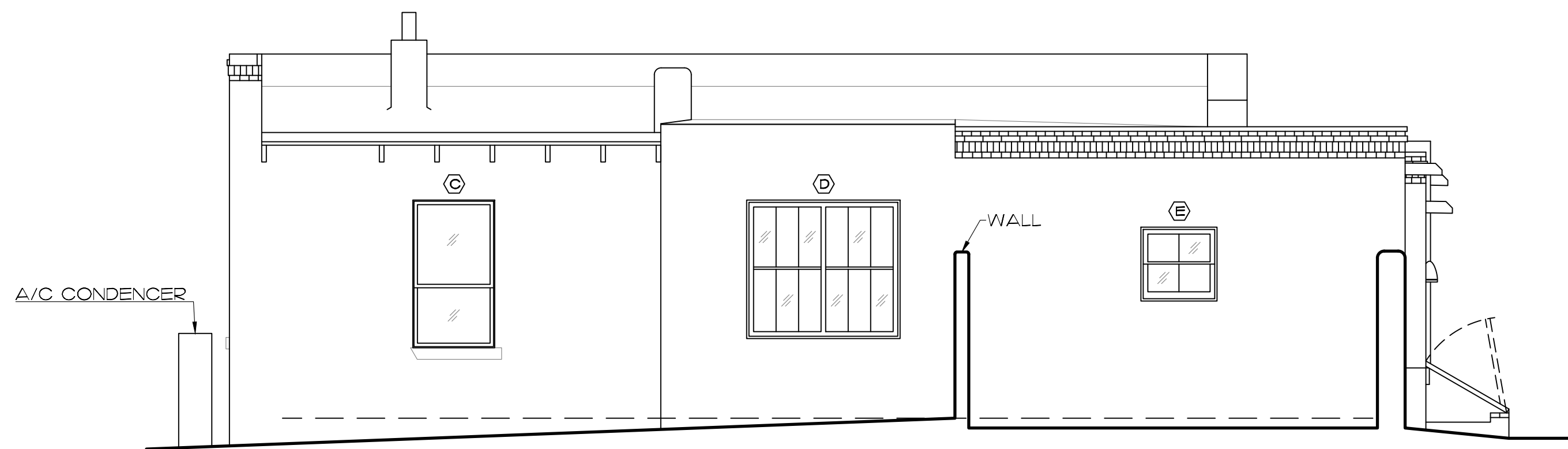

2 EXISTING SOUTH ELEVATION
A-4.1 SCALE: 1/4" = 1'-0"

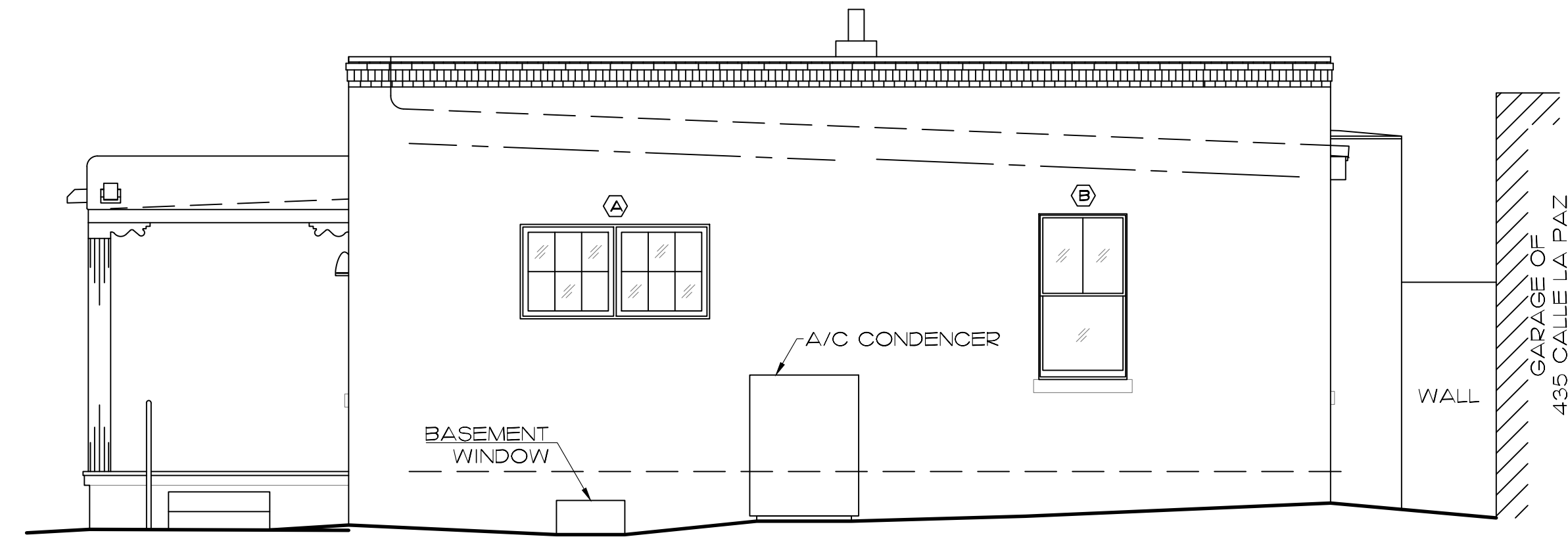

1 EXISTING WEST ELEVATION
A-4.1 SCALE: 1/4" = 1'-0"

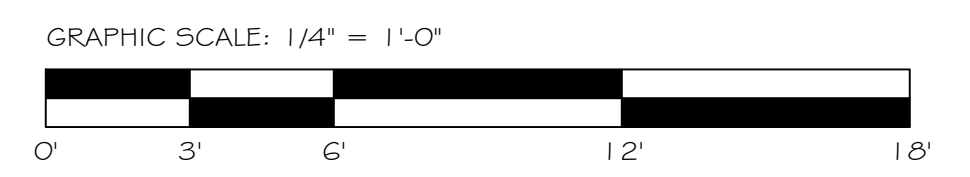

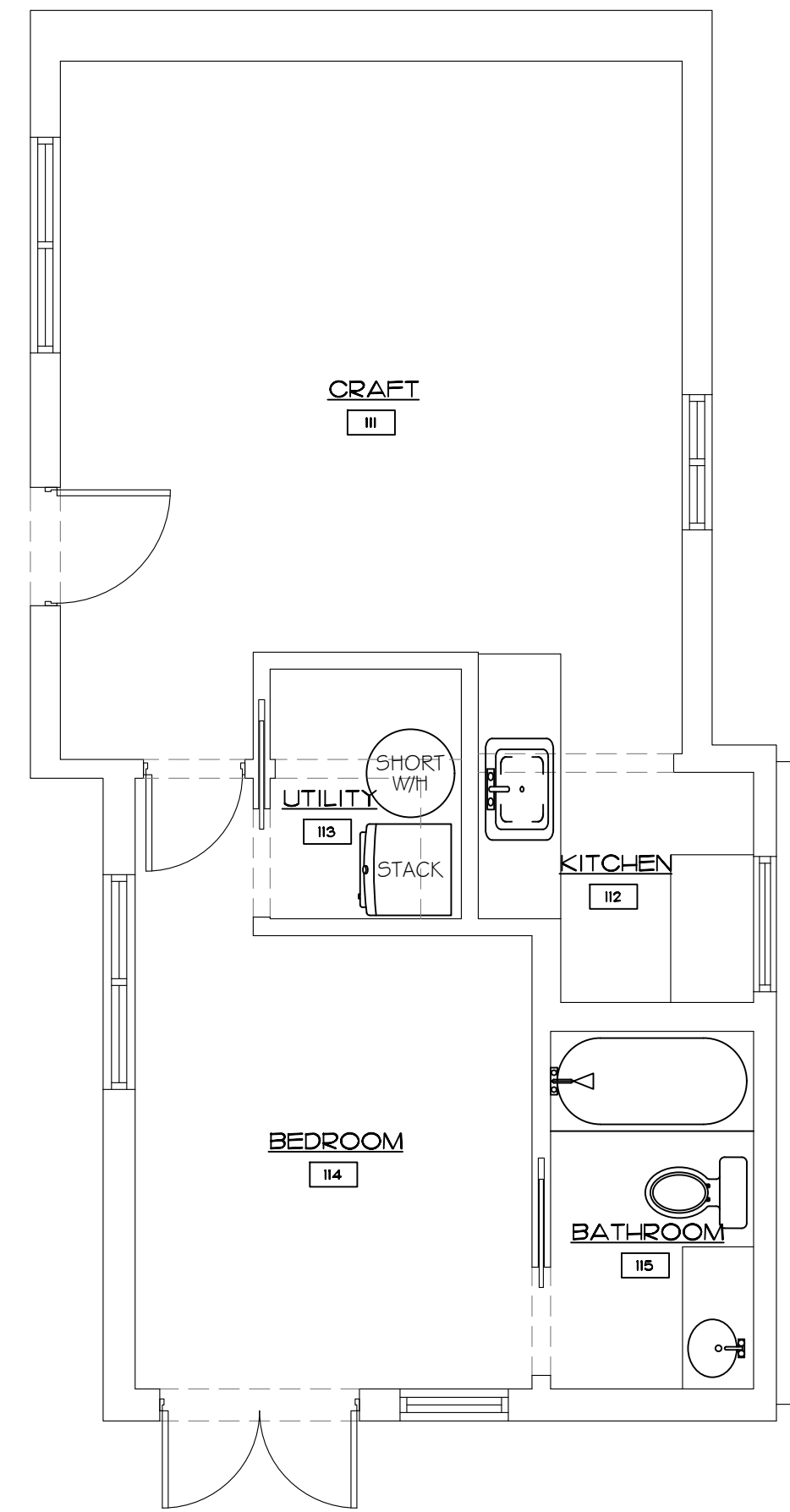

1 CASITA - EXISTING FLOOR PLAN
A-5.0 SCALE: 1/4" = 1'-0"

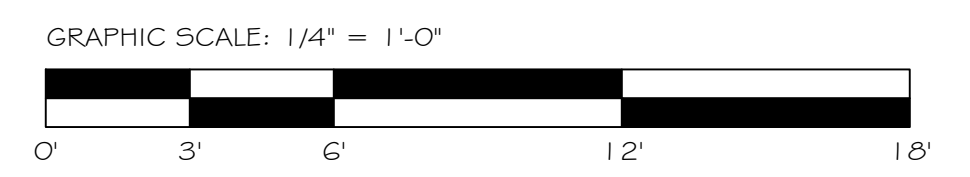

MARTINEZ
ARCHITECTURE
STUDIO PC
1524 PASEO DE PERALTA SANTA FE
505.989.4958 studio@martinezarch.com

RENOVATION
433 CALLE LA PAZ
SANTA FE,
NEW MEXICO

JULY 3, 2025

CASITA -
EXISTING
FLOOR PLAN

A
5.0

SET #
AUSTIN-GREGORY - 2509

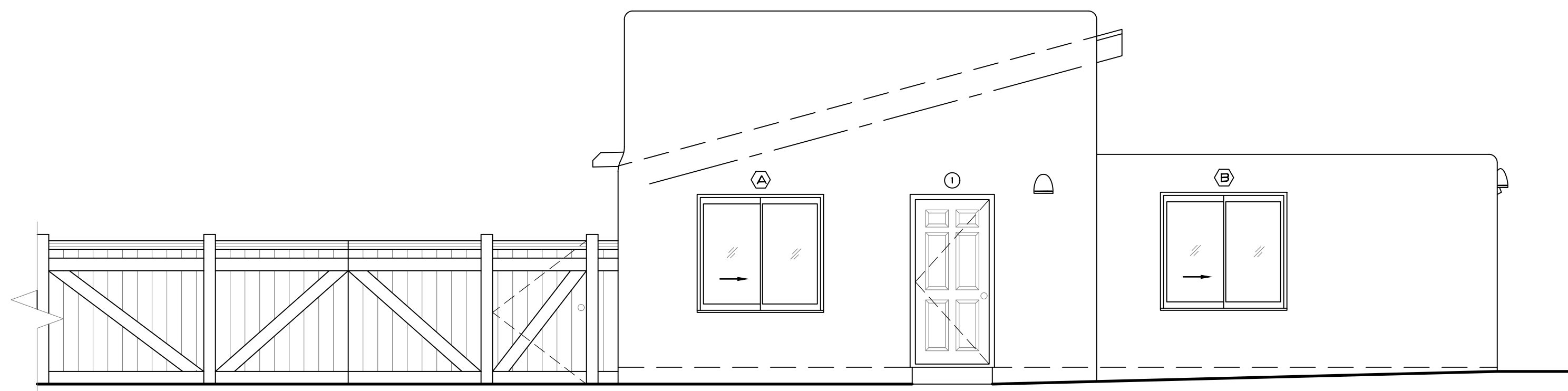

2 EXISTING WEST ELEVATION
A-6.0 SCALE: 1/4" = 1'-0"



1 EXISTING SOUTH ELEVATION
A-6.0 SCALE: 1/4" = 1'-0"

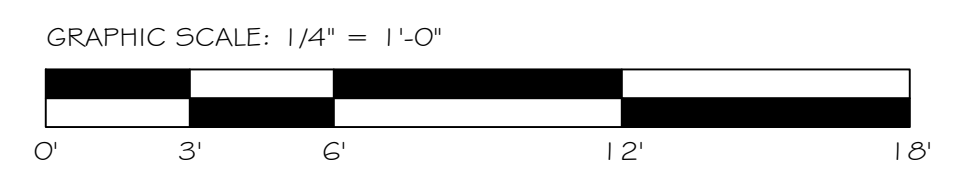

MARTINEZ
ARCHITECTURE
STUDIO PC
1524 PASEO DE PERALTA SANTA FE
505.989.4958 studio@martinezarch.com

RENOVATION
433 CALLE LA PAZ
SANTA FE, NM
NEW MEXICO

JULY 3, 2025

CASITA -
WEST &
SOUTH
ELEVATIONS

A
6.0

SET #

AUSTIN-GREGORY - 2509

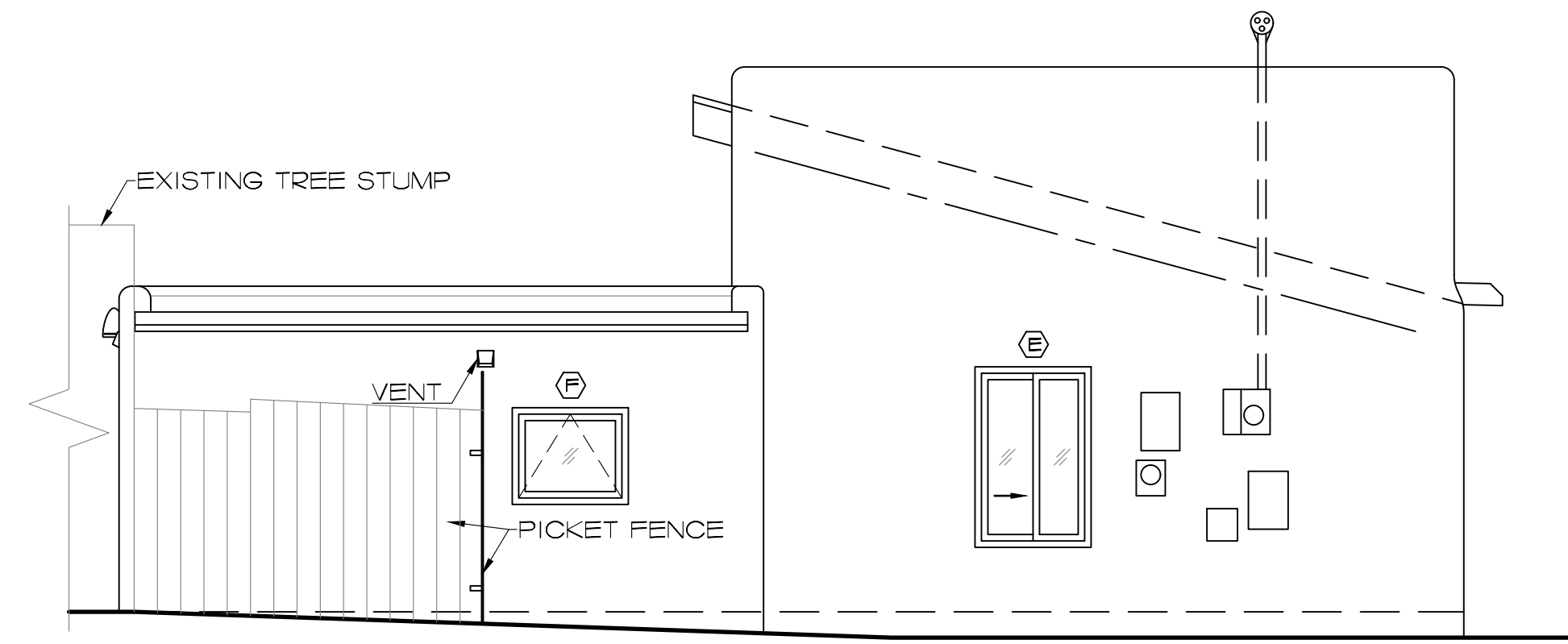

2 EXISTING EAST ELEVATION
A-6.1 SCALE: 1/4" = 1'-0"

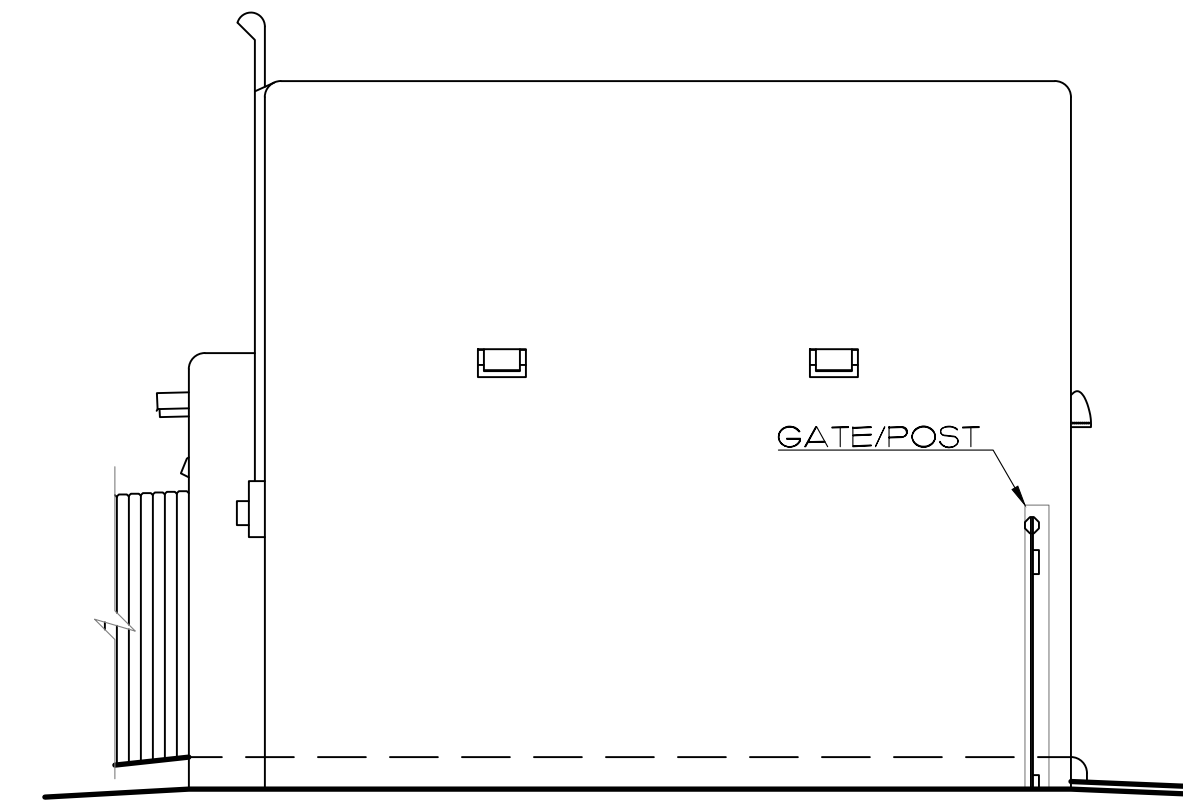

1 EXISTING NORTH ELEVATION
A-6.1 SCALE: 1/4" = 1'-0"

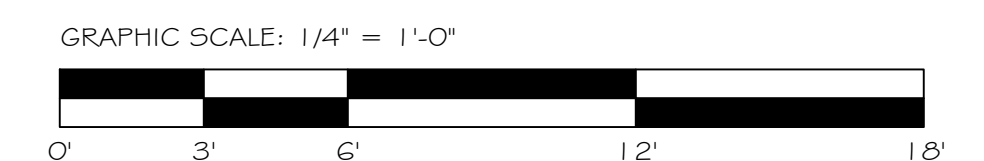

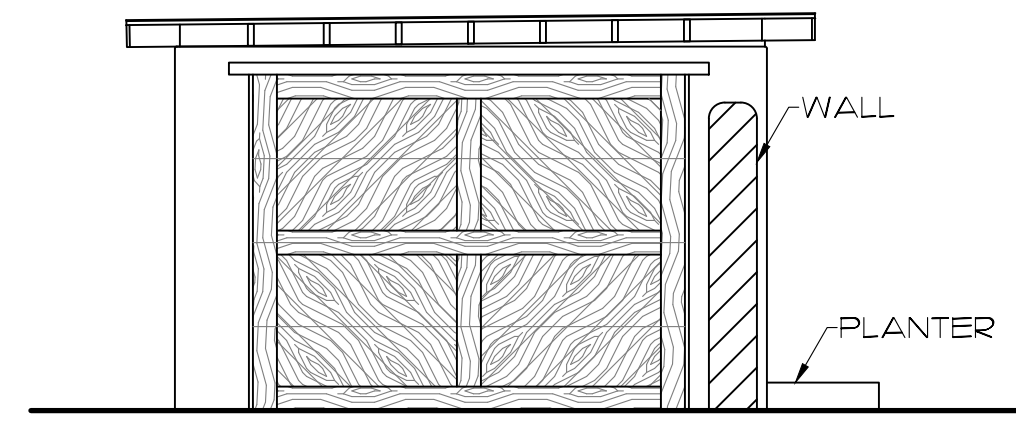

1 EXISTING WEST ELEVATION
A-6.2 SCALE: 1/4" = 1'-0"

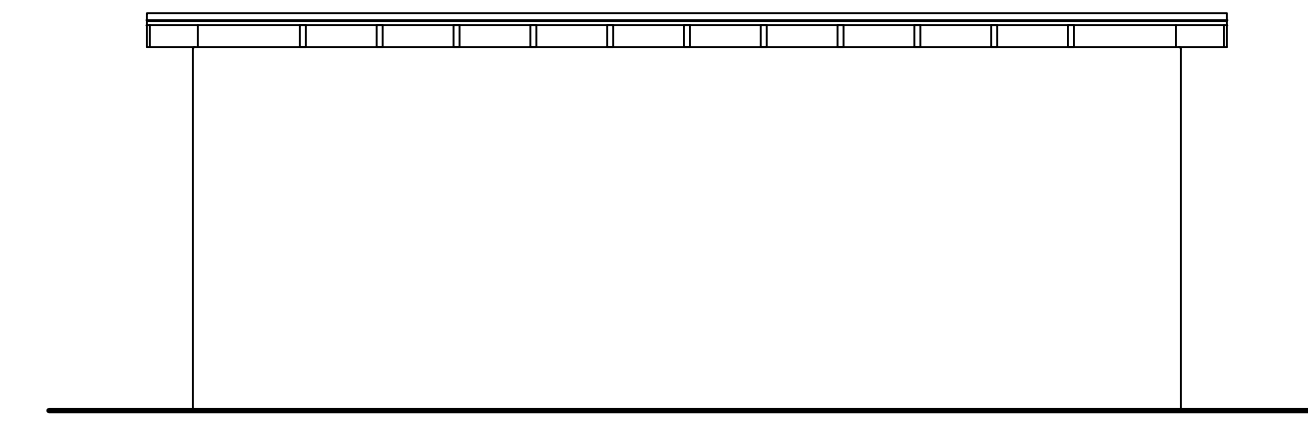

2 EXISTING NORTH ELEVATION
A-6.2 SCALE: 1/4" = 1'-0"

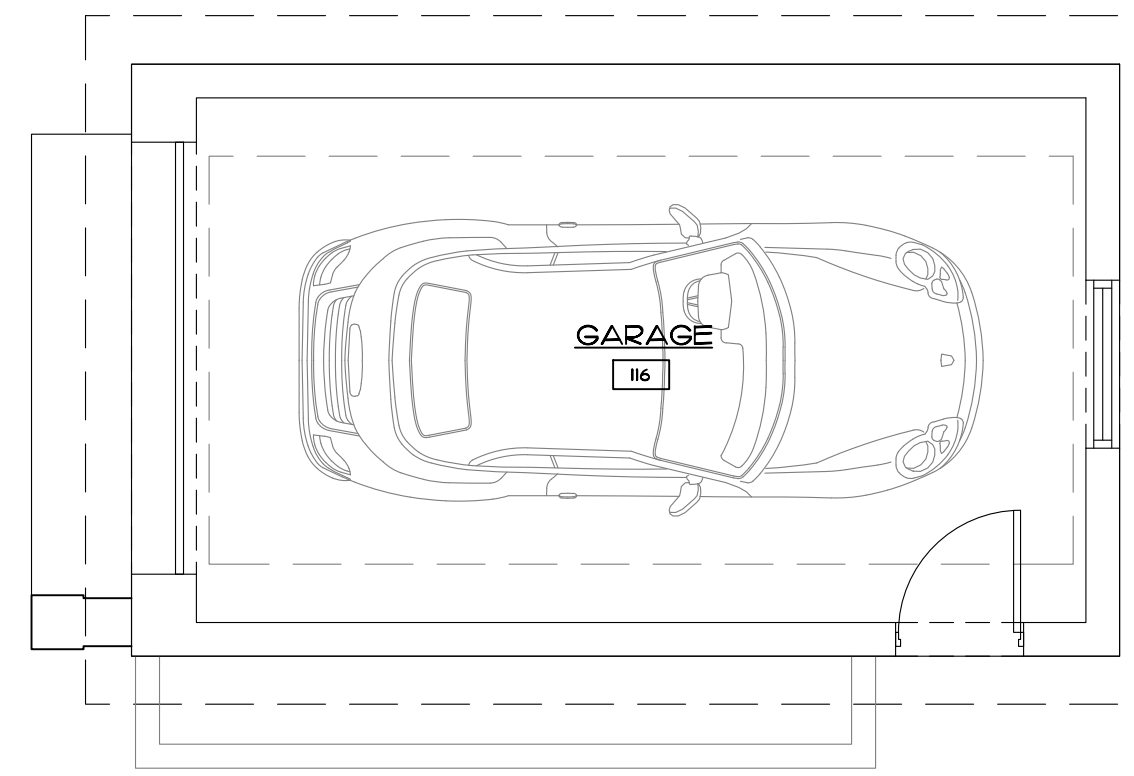

5 EXISTING FLOOR PLAN
A-6.2 SCALE: 1/4" = 1'-0"

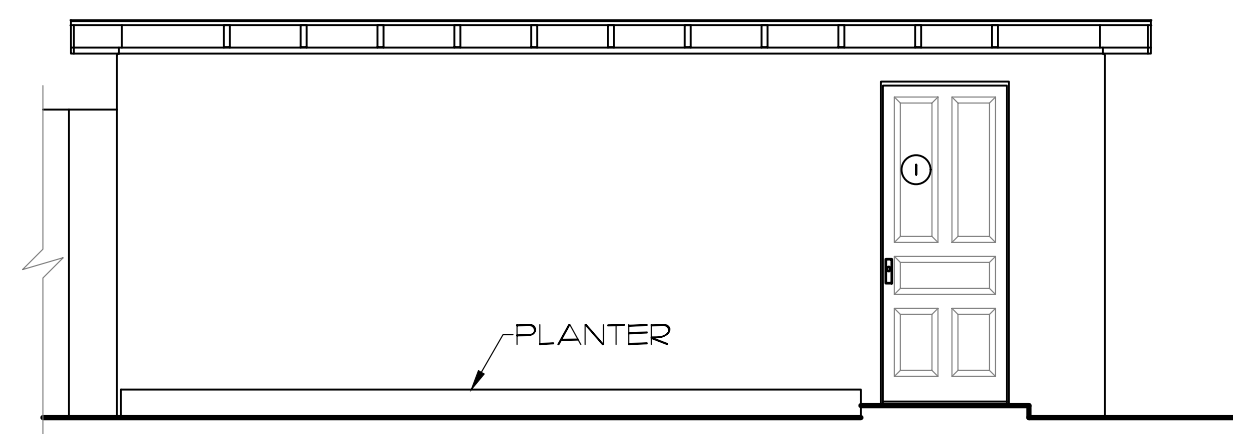

3 EXISTING SOUTH ELEVATION
A-6.2 SCALE: 1/4" = 1'-0"

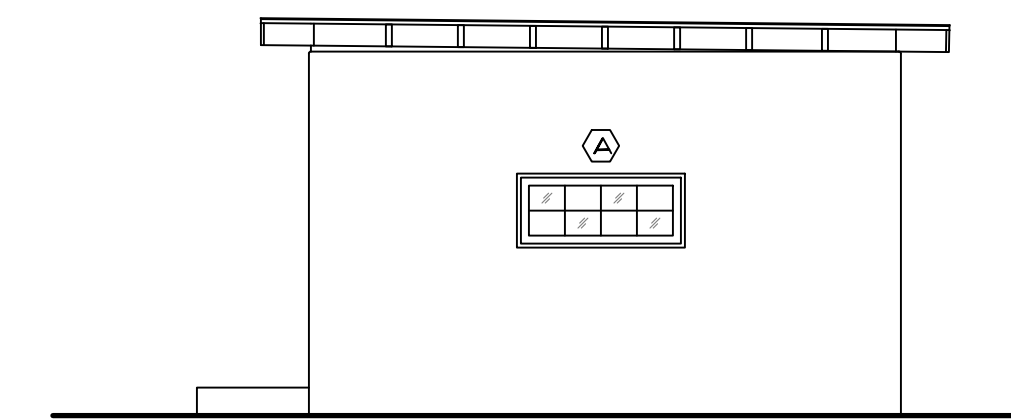

4 EXISTING EAST ELEVATION
A-6.2 SCALE: 1/4" = 1'-0"

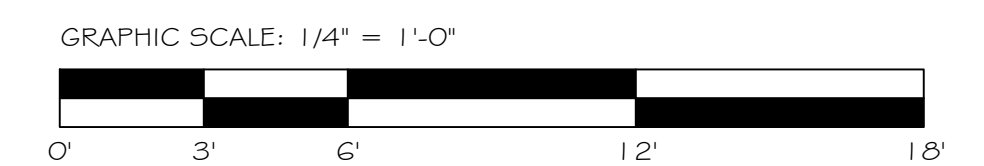

MARTINEZ
ARCHITECTURE
STUDIO PC
1524 PASEO DE PERALTA SANTA FE
505.989.4958 studio@martinezarch.com

RENOVATION
433 CALLE LA PAZ
SANTA ANITA FEE,
NEW MEXICO

JULY 3, 2025

GARAGE
FLOOR AND
ELEVATIONS
- NO
CHANGES
PROPOSED

A
6.2

SET #

AUSTIN-GREGORY - 2509